

Taurus Series Multimedia Players

V1.5.0 NS120100636



Application Solution

Contents

Contents	i
1 Overview.....	1
1.1 About This Solution.....	1
1.2 Characteristics of the Application Solution	1
1.2.1 Synchronous Playing.....	1
1.2.2 Smart Brightness Adjustment	2
1.2.3 4G Module	2
1.2.4 Cluster Management	3
1.3 Software Acquiring Methods.....	3
2 AD Player and Mirror Screen Solution.....	5
2.1 Overview.....	5
2.2 Single Application	7
2.2.1 Networking Diagram	7
2.2.2 Required Software	7
2.2.3 Relevant Configurations	7
2.3 Cluster Application.....	8
2.3.1 Networking Diagram	8
2.3.2 Required Software	8
2.3.3 Required Hardware Devices.....	8
2.3.4 Relevant Configurations	9
2.4 Splicing	12
2.4.1 Networking Diagram	12
2.4.2 Required Software	13
2.4.3 Relevant Configuration	13
3 Post Screen Solution.....	15
3.1 Overview.....	15
3.2 Networking Diagram	17
3.3 Required Software	17
3.4 Required Hardware Devices.....	17
3.5 Relevant Configuration	17

4 General Operations.....	21
4.1 Taurus Login upon ViPlex Handy (Android and iOS).....	21
4.2 Taurus Login upon ViPlex Express (Windows)	21

XI'AN NOVASTAR TECH CO.,LTD

1 Overview

1.1 About This Solution

Taurus series products are the second-generation multimedia players developed by NovaStar specially designed for full-color LED displays, and applicable to all kinds of display devices as well as many application scenes.

AD player, mirror screen and post screen are used here as examples to describe the application solution of Taurus series products. Pictures of Taurus series products used in networking diagram are taken from T6 model.

For more information of Taurus series products, please visit www.novastar.tech to download relevant documents.

1.2 Characteristics of the Application Solution

1.2.1 Synchronous Playing

This function makes several displays play the same image at the same time with high accuracy based on advanced synchronous playing and scheduling technologies.

The synchronous playing function could be enabled for different displays as long as following three requirements are met:

- The synchronous playing function has been enabled on the ViPlex or VNNOX.
- The time of multiple Taurus products are synchronized.
- Playing plans of multiple Taurus products are the same without random transition or media.

Advantages of the synchronous playing function are shown in [Table 1-1](#).

Table 1-1 Synchronous playing

Object	Advantage
User	Improve advertisement and information broadcast effects
Environment	Improve city image and make the city more colorful
Display	Improve visual experience

Time could be synchronized through NTP and RF modes from which the user could select one as required:

- NTP time synchronization: Taurus time synchronization is based on NTP server. No hardware is required to be added, and time synchronization accuracy depends on network speed. Consequently, network traffic will be consumed by using 4G network.
- RF time synchronization: Master and slave devices are required to be set for Taurus. Time of the slave device is synchronized with that of the master device through RF signal, and therefore RF device is required. This time synchronization method is applicable to events with high time synchronization requirement and does not consume network traffic, but its signal receiving depends on the environment and is limited by distance.

1.2.2 Smart Brightness Adjustment

Smart brightness adjustment includes auto brightness adjustment and timing brightness adjustment.

- Auto brightness adjustment: Display brightness will automatically adjust according to environment brightness.
- Timing brightness adjustment: Display brightness will automatically adjust to a specific value at a given point of time.

Taurus products have brightness sensor connectors. Connect the light sensor and set smart brightness adjustment rules on ViPlex or VNNOX to enable the smart brightness adjustment function.

Advantages of smart brightness adjustment are as shown in [Table 1-2](#).

Table 1-2 Smart brightness adjustment

Object	Advantage
User	Reduce manual operations
Environment	Avoid light pollution
Display	Smarter

Taurus products support manual brightness adjustment as well.

1.2.3 4G Module

Some Taurus series product models support 4G module. To connect the Taurus to the Internet via 4G network, buy the corresponding 4G module and install it according to the country or region of the service provider.

The Taurus can be connected to the Internet through the following three methods listed from the highest to the lowest priority:

- Wired network
- Wi-Fi network
- 4G network

When the three methods are all enabled, the Taurus will select signals automatically according to the priorities.

When mobile data network is enabled on ViPlex and priority requirements for signal selection are met, Taurus products with 4G module could connect to Internet via 4G network.

Advantages of 4G module are as shown in [Table 1-3](#).

Table 1-3 4G module

Object	Advantage
User	Solution transmission speed is fast without wiring operation
Environment	-
Display	All Internet connection methods are available to enable more application scenes

1.2.4 Cluster Management

Display quantity increases fast following with the development of smart city and commercial application, and cluster solution of NovaStar emerges to uniformly manage and monitor numerous displays in different places.

Advantages of cluster management are as shown in [Table 1-4](#).

Table 1-4 Cluster management

Object	Advantage
User	Remotely and uniformly manage and monitor numerous displays
Environment	Helpful for the development of the smart city
Display	Without limits on deployment position and quantity

1.3 Software Acquiring Methods

Table 1-5 Related software

Name	Type	Description	Address
ViPlex Handy	Mobile client	LAN-based screen management software for Android and iOS, which is mainly used for screen management, solution editing and publishing.	
ViPlex Express	PC client	LAN-based screen management software for Windows, which is mainly used for screen management, solution editing and publishing.	http://www.en.vnnox.com/#downloadT

Name	Type	Description	Address
VNNOX	Online software	One-stop cloud platform, which is mainly used for remote content publishing and device management.	www.en.vnnox.com

XI'AN NOVASTAR TECH CO.,LTD

2 AD Player and Mirror Screen Solution

2.1 Overview

AD player and mirror screen, the typical commercial display applications, are mainly used for information publishing and advertisement display, and can be placed at the shopping mall, hotel, office building, exhibition, bank, station and community.

There are two application modes for the mirror screen which is a mirror when the display is turned off.

There are many application modes for the AD player and mirror screen, and only typical applications are introduced in this chapter, including the single application, cluster application and splicing application.

Characteristics of the AD player and mirror screen of NovaStar are as shown in [Table 2-1](#).

Table 2-1 AD player and mirror screen

Characteristic	Description	Required Configuration
Support for synchronous display	Application of advanced synchronous playing and dispatching technologies realize high-accuracy synchronous playing for the same image on different displays.	<ul style="list-style-type: none">• Enable the synchronous playing function on the ViPlex or VNNOX.• Set time synchronizing rules on the ViPlex or VNNOX.
Support for smart brightness adjustment	Automatic and timing brightness adjustment could reduce manual operation, and brightness filtering technology could help to avoid brightness interference to realize stable display brightness.	Set smart brightness adjustment rules on ViPlex or VNNOX.
Support for splicing playing	Both individual playing and splicing playing are available for multiple displays.	Set splicing-related parameters on ViPlex.
Support for selling	During the process of	Edit solutions on ViPlex or

Characteristic	Description	Required Configuration
advertisements played in different time periods	solution scheduling, the user can divide time periods as required to play the specified list in every time period.	VNNOX.
Support for media switching without blackout	Blackout does not occur during media switching process.	No need to set.
Support for generating play log	The Taurus products can generate play log, and the user can check and export the log on VNNOX.	No need to set.

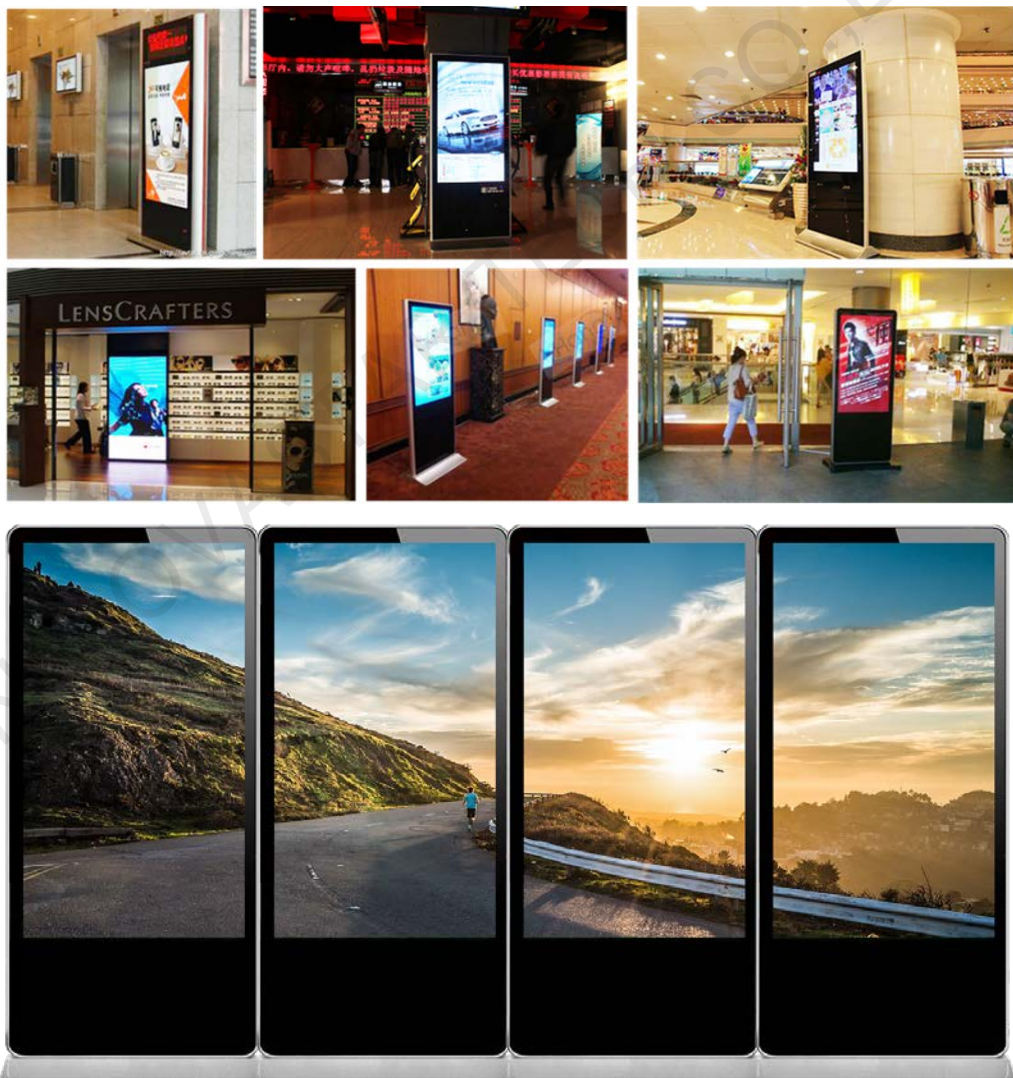

2.2 Single Application

2.2.1 Networking Diagram

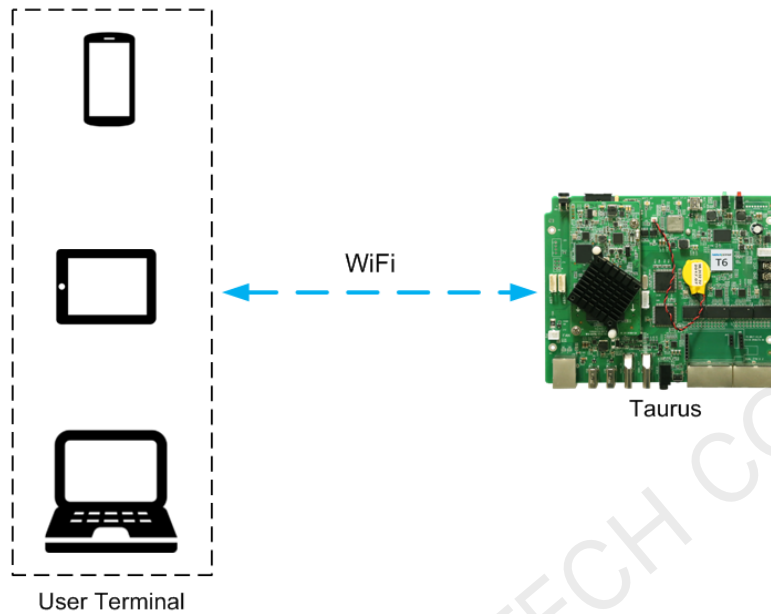

Taurus products provide Wi-Fi AP itself. After connecting to Wi-Fi AP with PC, Pad and mobile phone, enter the username and password to log in to the Taurus.

2.2.2 Required Software

- ViPlex Handy
- ViPlex Express

2.2.3 Relevant Configurations

No need to set. Refer to [4 General Operations](#) for specific operations to connect and log in to the Taurus products.

2.3 Cluster Application

2.3.1 Networking Diagram

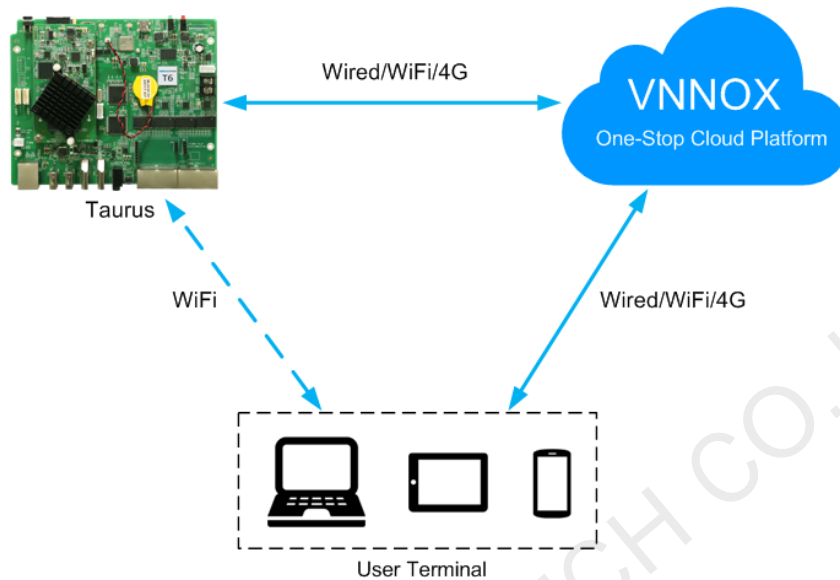

VNNOX could be accessed directly or by way of bridge connection. When bridge connection is selected, following three methods for Internet connection of Taurus products are available with priorities ranging from high to low:

- Wired network
- Wi-Fi network
- 4G network

When the three methods are all enabled, Taurus products will select signals automatically according to the priorities.

2.3.2 Required Software

- ViPlex Handy
- ViPlex Express
- VNNOX

2.3.3 Required Hardware Devices

Function	Required Hardware Device	Model
Synchronous playing	When RF time synchronization is used, it is required to purchase RF devices	E32-1W
Smart brightness adjustment	Light sensor	NS048D

2.3.4 Relevant Configurations

Before You Begin

- The login username and password for VNNOX and NovaLCT are acquired.
- Create solution(s) on VNNOX without random transition and random media of the solution(s).
- Create asynchronous players on VNNOX and associate the players with the License.
- Configurations required before monitoring have been done on NovaLCT and VNNOX.



Refer to software online help for specific operations of VNNOX and NovaLCT.

Acquiring Player Authentication Information

The authentication information is required when you bind asynchronous players on VNNOX to the Taurus through ViPlex.

- Step 1 Visit www.en.vnnox.com and log in to VNNOX AD.
- Step 2 Choose  > **Organization Management** > **System Management**.
- Step 3 Click the **Player Authentication** tab and view the authentication information.

Configuring ViPlex Handy (Android and iOS)

- Step 1 Log in to the Taurus. Refer to [4.1 Taurus Login upon ViPlex Handy \(Android and iOS\)](#).
- Step 2 Click screen name to enter **Screens** page.
- Step 3 Set rules for smart brightness adjustment.
 1. Choose **Screen Settings** > **Brightness Control**.
 2. Click **Brightness Mode**, select **Smart**, and click **OK**.
 3. Click **Smart Brightness Adjustment Parameters**.
 4. Click **Edit**.
 5. Click  to set rules for timed brightness adjustment. Then click **OK**.
 6. Click  to set rules for auto brightness adjustment. Then click **OK**.
 7. Click **Auto Brightness Adjustment Parameters** to set the corresponding relation between ambient brightness and screen brightness.
 8. Click **OK**.
- Step 4 Set the connection method between the Internet and Taurus.

Priorities of wired network, Wi-Fi Sta and 4G network range from high to low. When the three methods are all enabled, the Taurus will select signals automatically according to the priorities.

- Wired network: When static IP address is required, choose **Network Settings** > **Wired Network Settings**, turn **DHCP** off, enter the static IP address of the Taurus, and click **OK**.

- Wi-Fi Sta: Choose **Network Settings > Wireless Network Settings**, and turn **WiFi** on. Click the Wi-Fi name of the external router and enter the Wi-Fi password, and click **OK**.
- 4G network: Choose **Network Settings > Mobile Data Settings**, and turn **Mobile Data** on.

Step 5 Bind the asynchronous player.

1. Choose **Remote Management > VNNOX**.
2. Set the VNNOX server and player authentication information.
3. Click **Obtain** and select a player from the drop-down box of **Player**.
4. Click **OK** after setting.

Step 6 If display remote monitoring is required, perform the following procedures. Otherwise, ignore this step.

1. Choose **Remote Management > NovaiCare**.
2. Select the service node of the NovaiCare from the drop-down box of **Server**.
3. Click the right side of **Owner** line.
4. Enter the username for login NovaiCare in the pop-up dialog box, and click **OK**.
5. Click **OK** after setting.

Step 7 Repeat above steps to configure other Taurus products in cluster till all Taurus products have been configured.

Configuring ViPlex Express (Windows)

Step 1 Log in Taurus and see detailed operations in [4.2 Taurus Login upon ViPlex Express \(Windows\)](#).

Step 2 Select **Screen Control**.

Step 3 Set rules for smart brightness adjustment.

1. Select **Brightness adjustment**.
2. Select the target terminal in the terminal list.
3. Click **+** on the **Smart** page.
4. Set rules for timed brightness adjustment and click **Add**.
5. Set rules for auto brightness adjustment and click **Add**.
6. Click **Close**.
7. Click **Apply**.

Step 4 Set the way to connect Taurus to the Internet.

The priority of wired network, Wi-Fi network and 4G network is from high to low. If all of the three ways are enabled, the Taurus will choose signal automatically according to the priority order.

1. Select **Network configuration**.
2. Select the target terminal in the terminal list and perform the following operations according to actual needs.

- Wired network: If it is required to set static IP address, deselect **Dynamic DHCP**, enter the IP address information of the Taurus and then click **Apply** in the **Wired network configuration** section.
- Wi-Fi network: Turn on **Wi-Fi** in the **Wi-Fi configuration** section. Double click the Wi-Fi name of external router and then enter Wi-Fi password and click **OK**.
- 4G network: In the **Mobile network configuration** area, turn on mobile network.

Step 5 Bind asynchronous players.

1. Select **Server configuration**.
2. Select the target terminal in the terminal list.
3. In **Configure parameters for connecting screens to VNNOX**, configure VNNOX server and player authentication information.
4. Click  next to **Player** and select a player.
5. Click **Bind**.

Step 6 If you want to monitor displays remotely, please perform this step; otherwise, skip this step.

1. In **Configure parameters for connecting screens to NovaiCare**, select a server and enter the login user name.
2. Click **Send**.

Step 7 Repeat above steps until all the Taurus products in the cluster are configured.

Configuring VNNOX

When setting timing rules and synchronous playing upon ViPlex, every Taurus product is required to be set individually, and batch setting is available for setting timing rules and synchronous playing upon VNNOX. When the public network is available, VNNOX is recommended for batch configuration to reduce manual operations.

Step 1 Visit www.en.vnnox.com and log in to VNNOX AD.

Step 2 Set time synchronization rule.

1. Choose  > **Players Management > Time Synchronization**.
2. Click **NTP server configuration**.
3. Configure NTP service information, and then click **Save&Close**.
4. Click **New** on the page of time synchronization task list.
5. Enter time synchronization task name and select time synchronization method, and then click **Next**.
 - **NTP**: Select a NTP server and then click **OK**.
 - **RF**: Select a time synchronization standard device and then click **OK**.
6. Click **Add** in the **Players** tab of the time synchronization task attribute page.
 - NTP time synchronization: Select all the players in cluster and then click **OK**.
 - RF time synchronization: Select all the slave players in RF network and then click **OK**.

7. When the time synchronization method upon RF network is selected, and NTP server is used for the time synchronization standard device, click **Configure** tab to set **NTP** to **Yes**, and select NTP server. Otherwise, ignore this step.
8. Click **Save** or **Save&Close**. Players added in the time synchronization task will perform time synchronization according to rules defined in the task.

Step 3 If the same image is required to be played by different screens, perform the following procedures. Otherwise, ignore this step.

1. Choose  > **Players Management > Players**.
2. Select asynchronous players corresponding to all Taurus series products requiring enabling the synchronous playing function.
3. Choose **Real-time control > Synchronous playback > Turn on sync play**.

Step 4 Associate with solution(s).

1. Choose  > **Players Management > Players**.
2. Select a player and click **Attribute**, or click a player name.
3. Select a solution from the drop-down box of parameter **associate solution**.
4. Perform the corresponding operation below according to the solution distribution type.
 - Manual: Click **Save&Close** to return to the player list page. Perform term 5.
 - Auto: Click **Save** or **Save&Close**. VNNOX will automatically distribute solutions to corresponding Taurus products.
5. Select the target player, and click **Update solution** to manually distribute solutions to corresponding Taurus products.
6. Repeat above steps to associate with solutions for other players in cluster till all players have been configured.

2.4 Splicing

This section will show you an example of splicing three displays horizontally from the left to right and using the external video source.

2.4.1 Networking Diagram

The following figure uses three displays splicing as an example to illustrate Taurus connection.

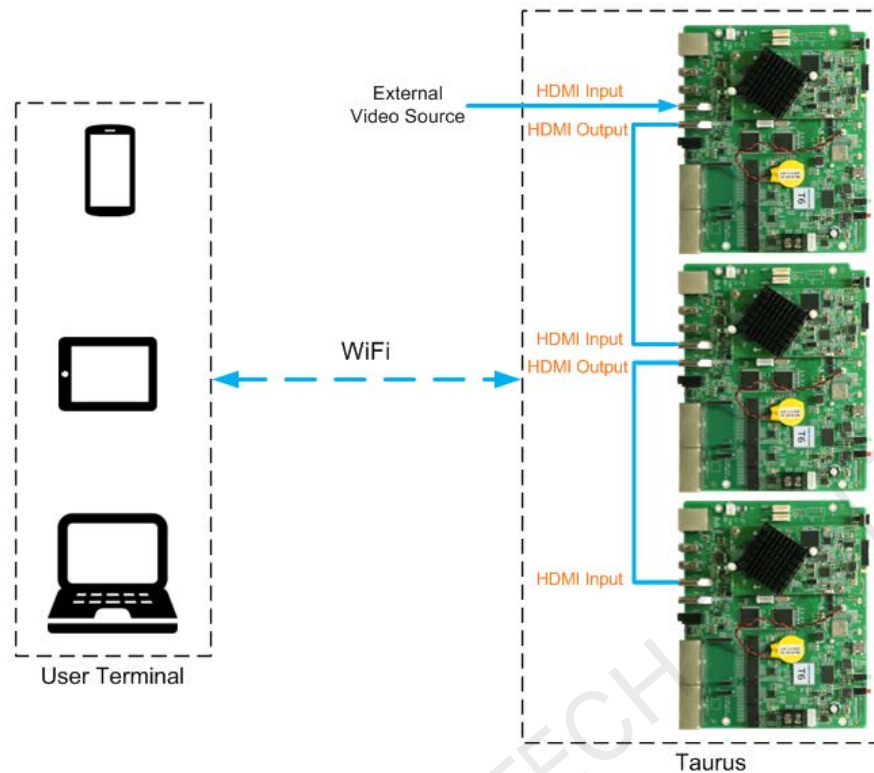

The Taurus product provides Wi-Fi AP itself. Connect to Wi-Fi AP of each Taurus product through PC, Pad and mobile phone, and then enter the username and password to log in to the Taurus.

2.4.2 Required Software

- ViPlex Handy
- ViPlex Express

2.4.3 Relevant Configuration

Before You Begin

Make sure that the displays have the same specifications.

Configuring ViPlex Handy (Android and iOS)

- Step 1 Log in to all the Taurus to be spliced. Refer to [4.1 Taurus Login upon ViPlex Handy \(Android and iOS\)](#) for specific operations.
- Step 2 Choose **Settings > Mode**.
- Step 3 Select **Screen Configuration Mode** and go back to the last page.
- Step 4 Choose **Screens**.
- Step 5 On the **Screen list** page, click  at the top right.
- Step 6 Enter a resolution and click **Query** to search for screens.

The online Taurus and offline Taurus with mosaic order that match your query will be displayed.

Step 7 (Optional) Click  to sort the Taurus with mosaic order by ascending mosaic order.

Step 8 Click **Mosaic**.

Step 9 Set the number of screens used for mosaic.

The number of screens cannot be greater than the ceiling integer of the value of "video source width / loading capacity width of the Taurus".

The loading capacity width of the Taurus is up to 4096 pixels.

Step 10 Set mosaic orders.

The system sets the horizontal offset of image automatically according to the mosaic order and the loading capacity width of the Taurus.

Offset = (*Mosaic order*-1) × Loading capacity width of the Taurus

For example, if the loading capacity width of the Taurus is 500 px, set the offset of the second screen to 500 px and the third screen to 1000 px.

Step 11 Set the video source of the first screen.

Configuring ViPlex Express (Windows)

Step 1 Log in Taurus and see detailed operations in [4.2 Taurus Login upon ViPlex Express \(Windows\)](#).

Step 2 Choose **Screen Control > Video source**.

Step 3 Select the target terminal in the terminal list.

Step 4 On the **Manual** page, configure all required parameters.

- **Video source type:** HDMI
- **X:** (*Mosaic order*- 1) × Loading capacity width of the Taurus. For example, if the loading capacity width of the Taurus is 500 px, set the offset of the second screen to 500 px and the third screen to 1000 px.
- **Y:** 0

If the first display uses the internal video source, set the **Video source type** of the first display to **Internal** and set the **Video source type** of other displays to **HDMI**.

Step 5 Click **Apply**.

Step 6 Repeat above steps to configure other Taurus products till all Taurus products have been configured.

3 Post Screen Solution

3.1 Overview

Post screens prevail on both sides of highways and roads following with the development of the smart city. Smart post screen has distinct advantages compared with the conventional post which features illumination and static advertisement only and requires new manufacture and installation in case of advertisement replacement, while the smart post provides functions including illumination, security monitoring, environment monitoring, emergency call, charging pile and LED display which used high-definition smart LED post screen for road leading, data release and advertising promotion.

Post screens can be used without quantity limits, and the display contents can be controlled individually or in batch based on cluster management method.

Characteristics of the post screen of NovaStar are as shown in [Table 3-1](#).

Table 3-1 Post screen

Characteristics	Description	Require Configuration
Support synchronous playing	Use advanced synchronous playing and scheduling technologies to make several displays play the same image at the same.	<ul style="list-style-type: none"> • Enable the synchronous playing function on the ViPlex or VNNOX. • Set time synchronizing rules on the ViPlex or VNNOX.
Support for smart brightness adjustment	Automatic and timing brightness adjustment could reduce manual operation, and brightness filtering technology could help to avoid brightness interference to realize stable display brightness.	Set smart brightness adjustment rules on ViPlex or VNNOX.
Support for selling advertisements played in different time periods	During the process of solution scheduling, the user can divide time periods as required to play the specified list in every time period.	Edit solutions on ViPlex or VNNOX.
Support for media switching without	Blackout does not occur during media switching	No need to set.

Characteristics	Description	Require Configuration
blackout	process.	
Support for generating play log	Taurus products can generate play log, and the user can check and export the log on VNNOX.	No need to set.
Support for remote solution publishing	VNNOX is a one-stop cloud platform which is mainly used for remote content publishing and device management.	Visit www.en.vnnox.com for register and login.
Support for environment monitoring	Onboard camera connector can monitor the environment surround the post screen.	No need to set.
Support for 4G module	After the 4G module is installed, the Internet can be connected via 4G network.	Turn on mobile data network on ViPlex.



3.2 Networking Diagram

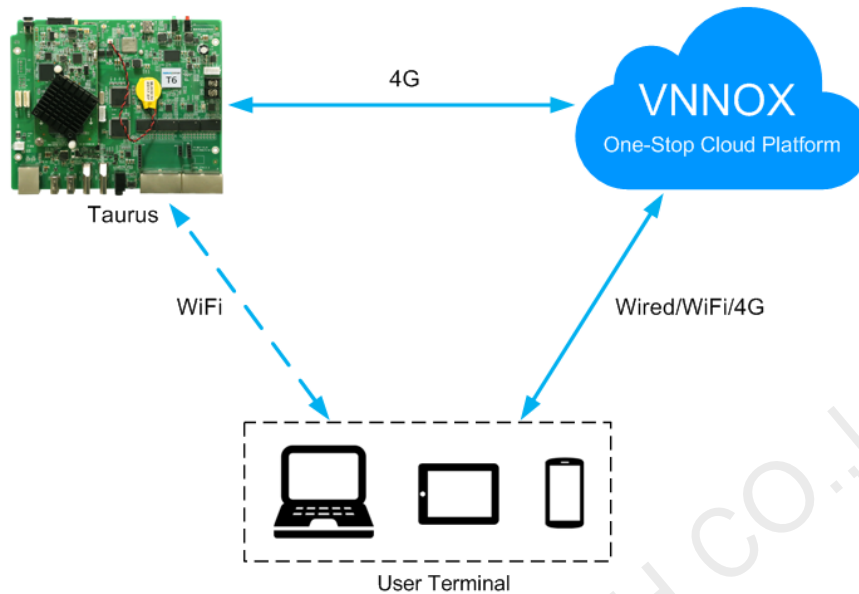

VNNOX could be accessed directly or by way of bridge connection to centrally manage post screens.

Taurus products can connect to Internet through the wired network, Wi-Fi and 4G network which is recommended for this solution.

3.3 Required Software

- ViPlex Handy
- ViPlex Express
- VNNOX

3.4 Required Hardware Devices

Function	Required Hardware Device	Model
Synchronous playing	When RF time synchronization is used, it is required to purchase RF devices	E32-1W
Smart brightness adjustment	Light sensor	NS048D

3.5 Relevant Configuration

Before You Begin

- Acquire the login username and password of VNNOX and NovaLCT.

- Create a solution on the VNNOX without random transition and random media.
- Create an asynchronous player which associates with License on the VNNOX.
- Complete configurations required to be done before monitor on NovaLCT and VNNOX.



Refer to software online help for specific operations of VNNOX and NovaLCT.

Acquiring player Authentication Information

The authentication information is required when you bind asynchronous players on VNNOX to the Taurus through ViPlex.



- Step 1 Visit www.en.vnnox.com and log in to VNNOX AD.
- Step 2 Choose  > **Organization Management** > **System Management**.
- Step 3 Click the **Player Authentication** tab and view the authentication information.

Configuring ViPlex Handy (Android and iOS)

- Step 1 Log in to the Taurus. Refer to [4.1 Taurus Login upon ViPlex Handy \(Android and iOS\)](#) for specific operations.
- Step 2 Click the screen name to enter the **Screens** page.
- Step 3 Set rules for smart brightness adjustment.
 1. Choose **Screen Settings** > **Brightness Control**.
 2. Click **Brightness Mode** to select **Smart**, and then click **OK**.
 3. Click **Smart Brightness Adjustment Parameters**.
 4. Click **Edit**.
 5. Click  to set rules for timed brightness adjustment. Then click **OK**.
 6. Click  to set rules for auto brightness adjustment. Then click **OK**.
 7. Click **Auto Brightness Adjustment Parameters** to set the corresponding relation between ambient brightness and screen brightness. Then click **OK**.
 8. Click **OK**.
- Step 4 Set Internet connection mode for the Taurus.
 1. Choose **Network Settings** > **Mobile Data Settings**.
 2. Turn **Mobile Data** on.
- Step 5 Bind the asynchronous player.
 1. Choose **Remote Management** > **VNNOX**.
 2. Set the VNNOX server and player authentication information.
 3. Click **Obtain** and select a player from the dropdown box of **Player**.
 4. Click **OK** after setting.
- Step 6 If display remote monitoring is required, perform the following procedures. Otherwise, ignore this step.
 1. Choose **Remote Management** > **NovaiCare**.

2. Select the service node of NovaiCare from the dropdown box of **Server**.
 3. Click the right side of **Owner** line.
 4. Enter the login username of NovaiCare in the pop-up dialog box, and click **OK**.
 5. Click **OK** after setting.
- Step 7 Repeat above steps to configure other Taurus products in cluster till all Taurus products have been configured.

Configuring ViPlex Express (Windows)

- Step 1 Log in Taurus and see detailed operations in [4.2 Taurus Login upon ViPlex Express \(Windows\)](#).
- Step 2 Select **Screen Control**.
- Step 3 Set rules for smart brightness adjustment.
1. Select **Brightness adjustment**.
 2. Select the target terminal in the terminal list.
 3. Click  on the **Smart** page.
 4. Set rules for timed brightness adjustment and click **Add**.
 5. Set rules for auto brightness adjustment and click **Add**.
 6. Click **Close**.
 7. Click **Apply**.
- Step 4 Set the way to connect Taurus to the Internet.
1. Select **Network configuration**.
 2. Select the target terminal in the terminal list.
 3. In the **Mobile network configuration** area, turn on mobile network.
- Step 5 Bind asynchronous players.
1. Select **Server configuration**.
 2. Select the target terminal in the terminal list.
 3. In **Configure parameters for connecting screens to VNNOX**, configure VNNOX server and player authentication information.
 4. Click  next to **Player** and select a player.
 5. Click **Bind**.
- Step 6 If you want to monitor displays remotely, please perform this step; otherwise, skip this step.
1. In **Configure parameters for connecting screens to NovaiCare**, select a server and enter the login user name. Click **Send**.
- Step 7 Repeat above steps until all the Taurus products in the cluster are configured.

Configuring VNNOX

When setting timing rules and synchronous playing upon ViPlex, every Taurus product is required to be set individually, and batch setting is available for setting

timing rules and synchronous playing upon VNNOX. When the public network is available, VNNOX is recommended for batch configuration to reduce manual operations.

Step 1 Visit www.en.vnnox.com and log in to VNNOX AD.

Step 2 Set time synchronization mode.

1. Choose  > **Players Management > Time Synchronization.**
2. Click **NTP server configuration.**
3. Configure NTP service information, and then click **Save&Close.**
4. Click **New** on the page of time synchronization task list.
5. Enter time synchronization task name and select time synchronization method, and then click **Next.**
 - **NTP:** Select the NTP server and then click **OK.**
 - **RF:** Select a time synchronization standard device and then click **OK.**
6. Click **Add** in the **Players** tab of the time synchronization task attribute page.
 - NTP time synchronization: Click all the players in cluster and then click **OK.**
 - RF time synchronization: Click all the slave players in RF network and then click **OK.**
7. When the time synchronization method upon RF network is selected, and NTP server is used for the time synchronization standard device, click **Configure** tab to set **NTP** to **Yes**, and select NTP server. Otherwise, ignore this step.
8. Click **Save** or **Save&Close.** Players added in the time synchronization task will perform time synchronization according to rules defined in the task.

Step 3 If the same image is required to be played by different screens, perform the following procedures. Otherwise, ignore this step.

1. Choose  > **Players Management > Players.**
2. Select asynchronous players corresponding to all Taurus series products requiring enabling the synchronous playing function.
3. Choose **Real-time control > Synchronous playback > Turn on sync play.**

Step 4 Associate with solution(s).

1. Choose  > **Players Management > Players.**
2. Select a player and click **Attribute**, or click a player name.
3. Select a solution from the drop-down box of parameter **associate solution.**
4. Perform the corresponding operation below according to the solution distribution type.
 - Manual: Click **Save&Close** to return to the player list page. Perform term 5.
 - Auto: Click **Save** or **Save&Close.** VNNOX will automatically distribute solutions to corresponding Taurus products.
5. Select the target player, and click **Update solution** to manually distribute solutions to corresponding Taurus products.
6. Repeat above steps to associate with solutions for other players in cluster till all players have been configured.

4 General Operations

The Taurus series products are designed with permanent Wi-Fi AP. This chapter takes Wi-Fi AP connection as an example to introduce the Taurus login method.

Other connection methods require hardware or software configuration. Refer to ***Taurus Series Multimedia Players Quick Start Guide*** for specific operations.

4.1 Taurus Login upon ViPlex Handy (Android and iOS)

Before You Begin



- Get the SSID and password of WiFi AP of the Taurus. The default SSID is “**AP+the last 8 digits**”. The default password is “**12345678**”.
- Get the password of the user “**admin**”. The default password of the user “**admin**” is “**123456**”.

Operating Steps

Step 1 Connect the WiFi AP of the Taurus products.

Step 2 Start ViPlex Handy.

ViPlex Handy automatically detects the Taurus and refreshes the screen list. Users can also swipe down to manually refresh the screen list.

- : Denotes that the Taurus is online and you can log in to it. Go to [Step 3](#).
- : Denotes that Taurus is offline and you cannot log into it.

Step 3 Tap **Connect** next the screen name.

Step 4 Enter the password for the "admin" user and then tap **Login**.

After successful login,  is displayed. ViPlex Handy saves the account information automatically.

4.2 Taurus Login upon ViPlex Express (Windows)

Before You Begin

- Get the SSID and password of WiFi AP of the Taurus. The default SSID is “**AP+the last 8 digits**”. The default password is “**12345678**”.

- Get the password of the user “**admin**”. The default password of the user “**admin**” is “**123456**”.



Operating Steps

Step 1 Connect the WiFi AP of the Taurus products.

Step 2 Start ViPlex Express.

Step 3 Click **Refresh** to refresh the screen list.

After detecting the Taurus, ViPlex Express will try to log in to the Taurus with the default account or the account used for last login.

- : Denotes that the Taurus is online and you can log in to it. Go to [Step 4](#).
- : Denotes the Taurus is offline and you cannot log in to it.
- : Denotes logging into the Taurus is successful.

Step 4 Click **Connect** next the screen information.

Step 5 Enter the password for the "admin" user and then click **OK**.

After successful login, ViPlex Express saves the account information automatically.

Copyright © 2019 Xi'an NovaStar Tech Co., Ltd. All Rights Reserved.

No part of this document may be copied, reproduced, extracted or transmitted in any form or by any means without the prior written consent of Xi'an NovaStar Tech Co., Ltd.

Trademark

 is a trademark of NovaStar Tech Co., Ltd.

Statement

You are welcome to use the product of Xi'an NovaStar Tech Co., Ltd. (hereinafter referred to as NovaStar). This document is intended to help you understand and use the product. For accuracy and reliability, NovaStar may make improvements and/or changes to this document at any time and without notice. If you experience any problems in use or have any suggestions, please contact us via contact info given in document. We will do our best to solve any issues, as well as evaluate and implement any suggestions.

Official website
www.novastar.tech

Technical support
support@novastar.tech