

# GEN VI RADIO

## INSTALLATION MANUAL

P1110

DD2362277  
Rev 06  
15 June 2018



**DAKTRONICS**

**Copyright © 2015-2018**

All rights reserved. While every precaution has been taken in the preparation of this manual, the publisher assumes no responsibility for errors or omissions. No part of this book covered by the copyrights hereon may be reproduced or copied in any form or by any means—graphic, electronic, or mechanical, including photocopying, taping, or information storage and retrieval systems—without written permission of the publisher.

*Daktronics trademarks are property of Daktronics, Inc. All other trademarks are property of their respective companies.*

# Table of Contents

<b>1</b>	<b>Installation</b> .....	<b>1</b>
	Radio Receiver .....	1
	<b>Indoor Scoreboards</b> .....	<b>1</b>
	Radio/Wire Switch .....	1
	<b>Outdoor Scoreboards</b> .....	<b>1</b>
	Radio Antenna Extension Kit .....	1
<b>2</b>	<b>Setting Radio Channels</b> .....	<b>2</b>
	Radio Control Overview .....	2
	Power-Up Sequence & LED Indicators .....	2
	<b>Server (Console)</b> .....	<b>2</b>
	<b>Client (Scoreboard)</b> .....	<b>3</b>
	Typical Radio Configurations .....	5
	<b>Single Controller System</b> .....	<b>5</b>
	<b>Multiple Controller System with Single Broadcast Group</b> .....	<b>6</b>
	<b>Multiple Controller with Multiple Broadcast Groups</b> .....	<b>7</b>
<b>3</b>	<b>Troubleshooting</b> .....	<b>9</b>
	Blank Scoreboard(s) .....	9
	Skipping, Periodic Blanking & Delays on Scoreboard(s) .....	9
	Radio Diagnostics .....	10
	<b>Identifying Radios with Diagnostic Support</b> .....	<b>10</b>
	<b>Radio Test Menus</b> .....	<b>10</b>
	Signal Strength & Missed Packet Tests .....	12
	Radio Channel Test .....	12
	Server Version Test .....	12
	<b>Additional Information</b> .....	<b>12</b>
<b>4</b>	<b>Daktronics Exchange and Repair &amp; Return Programs</b> .....	<b>14</b>
	Exchange Program .....	14
	Repair & Return Program .....	15
	Daktronics Warranty & Limitation of Liability .....	15
<b>A</b>	<b>Reference Drawings</b> .....	<b>17</b>
<b>B</b>	<b>Daktronics Warranty and Limitation of Liability</b> .....	<b>27</b>

*This page intentionally left blank.*

# 1 Installation

## Radio Receiver

The radio receiver has hook-and-loop fastener strips to secure it to the inside of the scoreboard. Most outdoor scoreboards also have an internal mounting bracket to which the radio receiver can attach. Refer to the component location drawings included in the scoreboard manual for the exact radio mounting location.

### Indoor Scoreboards

#### Reference Drawings:

Installation Diagram; Indoor Scbd Gen VI Radio Receiver .....	<b>DWG-1109105</b>
Radio Installation Details; Scoreboards .....	<b>DWG-1130990</b>
Radio Installation Pattern; Scoreboards .....	<b>DWG-1166771</b>

For standard indoor scoreboards (Tuff Sport® & ColorSmart®), refer to **DWG-1109105**.

**Note:** For scoreboards built after March 2013, refer also to **DWG-1130990**. These scoreboards have mounting holes for U bolts that protect the antenna. If holes need to be drilled into the scoreboard, use **DWG-1166771** as a guide.

### Radio/Wire Switch

#### Reference Drawings:

Install Details; Indoor Radio/Wire Switch .....	<b>DWG-168045</b>
---	-------------------

For indoor installations that have a radio/wire switch, refer to **DWG-168045**.

### Outdoor Scoreboards

#### Reference Drawings:

Installation Drawing; Outdoor Scbd Gen VI Radio Receiver .....	<b>DWG-1109181</b>
Outdoor Installation; Gen VI Radio & Base Station .....	<b>DWG-1109252</b>

For standard outdoor scoreboards, refer to **DWG-1109181**.

In certain situations, it is possible that both an All Sport® radio receiver and an RC-100 base station will be installed in the same scoreboard. For instance, a handheld RC-100 controller may be used when running practices, and then a wireless All Sport console controls the scoreboard during real games. In these cases, refer to **DWG-1109252**. The wireless device that takes precedence is the one that the scoreboard receiver finds active first, and it will control the scoreboard until the signal is no longer present.

**Note:** For dual-radio setups, Gen VI radio receiver requires firmware **Version 1.4** or greater, and RC-100 base station requires firmware **Version 3.7** or greater.

## Radio Antenna Extension Kit

An optional radio antenna extension kit (Daktronics part # 0A-1196-0243) is used to help ensure a better line-of-sight from the console to the scoreboard. For more information, refer to the **Remote Antenna Installation Quick Guide (DD3548818)**, available online at [www.daktronics.com/manuals](http://www.daktronics.com/manuals).

## 2 Setting Radio Channels

### Radio Control Overview

The radio receiver units used in Daktronics scoreboards have a channel (CHAN) switch that can be set from 1–8. The receivers also have a broadcast group (BCAST) switch that can be set from 1–8. The broadcast group defines a group of radio receivers that “listen” to the channel selected on the channel switch as well as “listen” for data sent out on their broadcast channel.

**Note:** Gen VI units sold internationally (Europe/Asia) only have broadcast groups 1–4.

Each radio receiver will accept data sent from the broadcast channel of its respective broadcast group (either 1–8), as well as data sent from the “Master Broadcast” channel. This is selected when the console is set to BCAST 0 and CHAN 00.

The radio settings in the console (transmitter) must match the settings in the scoreboard (receiver). By default, both devices are set to **BCAST 1, CHAN 01**. The installation drawings in **Appendix A** show the proper way to set the channel and broadcast group numbers for the receiver. The operator must then enter these specific numbers when prompted during console startup.

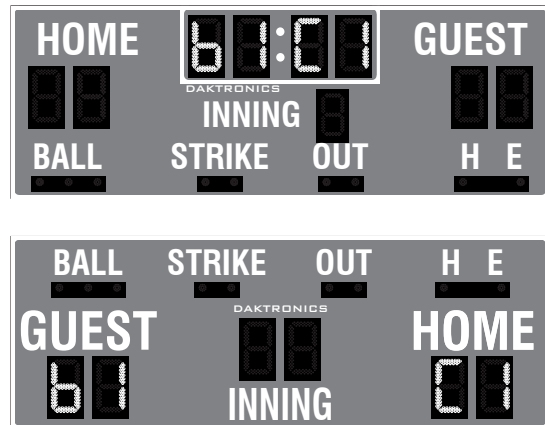

**Figure 1:** Radio Settings in Clock or Score Digits

To determine the settings of a scoreboard without accessing the receiver, first power it down and shut off any radio-equipped consoles in the area. Next, power the scoreboard back up and watch for the radio settings. The settings will appear as “bX CY” where **X** is the current broadcast group and **Y** is the current channel.

The settings are typically displayed in the clock digits or Home and Guest score digits, depending on the scoreboard model. Refer to **Figure 1**.

The console automatically detects when a radio transmitter is installed and will prompt for the transmitter settings after a valid sport code is entered.

### Power-Up Sequence & LED Indicators

The sections below outline the power-up sequence of both the client (scoreboard) and server (console) sides of the radio system under normal operating conditions. LED indicator locations and descriptions are also provided.

#### Server (Console)

1. Power ON – the **POWER** indicator (green LED) on rear of console illuminates.
2. While the console displays the software version on the LCD, the radio detects if it is connected to the console.
  - a. Once a console connection is detected, the radio boots up in Server Mode.
  - b. The **STATUS** indicator (amber LED) on the back of the console illuminates.

3. The console will ask to **Resume Game?** – select one of the following choices:
  - **[Yes]** – The console immediately begins sending information over the radio link, using the channel it was set to when last shut off.
  - **[No]** - (see below)
    - a. After entering or accepting the Sport Code, the console checks if the radio is installed. If detected, the console displays the current Broadcast and Channel numbers.
    - b. Accepting the listed values results in no changes to the radio, and the console begins sending information over the radio link.
    - c. Changing the listed values updates the settings, and the console begins sending data over the radio link on the new channel.

Refer to **Typical Radio Configurations (p.5)** for information about changing the radio settings in the console.

**Figure 2** shows the LED indicators on the radio transmitter, located on the rear of the console.

- **STATUS** (amber LED) – **Should always be ON when installed in a console**; signifies that the radio is operating in Server Mode
- **DATA** (red LED) – Active when data is received from the console and passed to the radio transmitter
- **POWER** (green LED) – Illuminates when power is applied to the transmitter

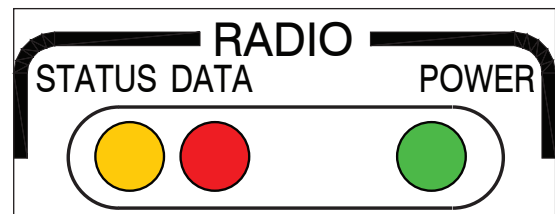

**Figure 2:** Radio Transmitter (on Rear of Console)

## Client (Scoreboard)

### Reference Drawings:

- Installation Diagram; Indoor Scbd Gen VI Radio Receiver ..... **DWG-1109105**
- Installation Drawing; Outdoor Scbd Gen VI Radio Receiver ..... **DWG-1109181**

To locate and access the receiver, refer to the service documentation for the particular scoreboard model.

1. Power ON – the **POWER** indicator (green LED) illuminates.
2. After an approximately seven-second delay to allow the scoreboard to perform a segment test, “b# C#” displays on the scoreboard, followed by “US” or “EU” depending on region.
  - “US” – Domestic (US/Canada) radio with a higher transmission power and access to all Broadcast Groups.
  - “EU” – International (Europe/UK etc) radio with a lower transmission power and access to Broadcast Groups 1-4 only.

**Note:** Mixed radio types are not compatible.

3. The radio receiver listens for a server on the following channels, in order:
  - a. B# C## - the exact channel the radio is set to via its switches
  - b. B# C00 – the broadcast channel
  - c. B0 C00 – the master broadcast channel
  - d. Diagnostics Channel – see **Radio Diagnostics (p.10)**
  - e. The sequence then repeats.
4. The receiver searches until a server on one of those channels is detected. The **DATA OUT** indicator (red LED) will flash periodically while searching.
5. Once locked onto a server, the **RADIO IN RANGE** indicator (amber LED) illuminates. The radio will remain on that channel until the server is removed, powered down, or the client is powered down.

**Note:** Refer to **DWG-1109105** (indoor) or **DWG-1109181** (outdoor) for instructions on changing the channel and broadcast groups inside the radio receiver.

**Figure 3** shows the LED indicators on the radio receiver.

- **POWER** (green LED) – Illuminates when power is applied to the receiver
- **RADIO IN RANGE** (amber LED) – Illuminates when a server (radio-equipped console) is active on the receiver's broadcast group channel
- **DATA OUT** (red LED) – Randomly flashes when data is being received from a server; regularly pulses when searching for a server

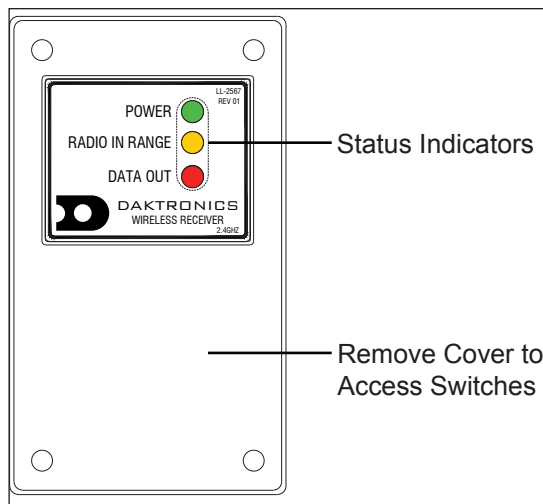

**Figure 3:** Radio Receiver w/ Cover



# Typical Radio Configurations

There are three different radio scenarios that can be accommodated: a single controller system, a multiple controller system with a single broadcast group, and a multiple controller system with multiple broadcast groups. Each of these configurations is described in detail in the following sections.

## Single Controller System

In a single controller system (**Figure 4**), all radio receivers and all scoreboards receive signal from the same console at all times. The default channel and broadcast group settings on the receiver are not typically modified. An example of this type of system is a football field with a scoreboard in one or both end zones displaying the same data.

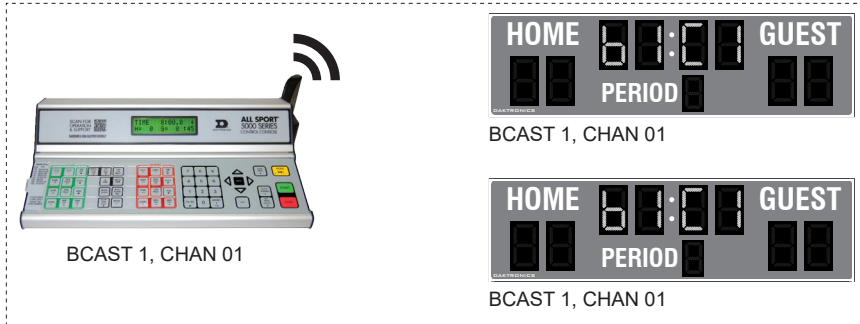

**Figure 4:** Single Control Console

Typically, all single controller systems will use the default setting BCAST = 1, CHAN = 1. All radio receivers in the system must be set to the same values.

Display	Action
<p>The LCD will toggle between these 2 screens:</p> <div style="border: 1px solid black; padding: 5px; margin-bottom: 10px;"> <p>RADIO SETTINGS BCAST X CHAN YY</p> </div> <div style="border: 1px solid black; padding: 5px; margin-bottom: 10px;"> <p>ENTER TO ACCEPT CLEAR TO MODIFY</p> </div> <div style="border: 1px solid black; padding: 5px;"> <p>BCAST GROUP X* RADIO CHAN YY</p> </div> <p>X = broadcast group number YY = channel number</p>	<p>The LCD shows the current radio settings along with a prompt to accept or modify these values.</p> <p>If the radio settings are correct press <b>&lt;ENTER&gt;</b>.</p> <p>If these values are incorrect, press <b>&lt;CLEAR&gt;</b>, and the LCD at bottom left is shown, allowing edit of the channel or broadcast group setting.</p> <p><b>Broadcast Group Setting</b> [1] Use this setting for all single controller systems. Use the number keys to edit this value and press <b>&lt;ENTER&gt;</b> to accept. The asterisk will move to the channel setting.</p> <p><b>Channel Setting</b> [1-8] Edit the channel number to the desired value and press <b>&lt;ENTER&gt;</b> to accept. The CHAN switch on the receiver must match this value.</p>

## Multiple Controller System with Single Broadcast Group

In a multiple controller system with a single broadcast group (**Figure 5**), there may be one console for each scoreboard and/or one master controller that can run every scoreboard at one time or take control of a specific scoreboard. An example of this type of system is a softball complex with individual scoreboards on several different fields.

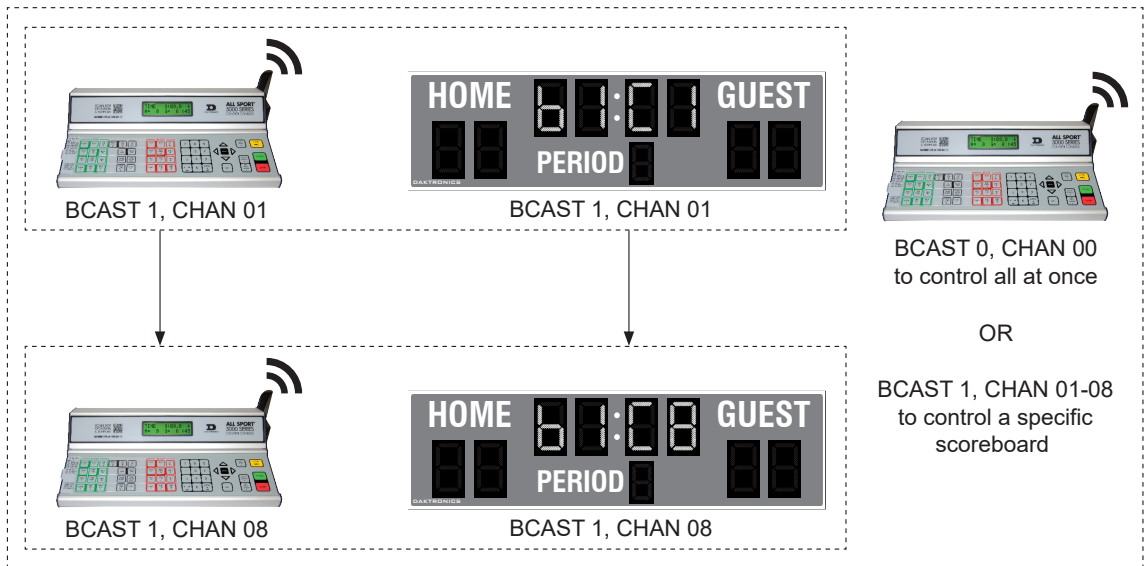

**Figure 5:** Single Broadcast Group

Multiple controller systems typically use Broadcast 1 and Channel 1 for the first controller and Channels 2–8 for all remaining controllers. All radio receivers in the system must be set to Broadcast 1 (BCAST 1).

Display	Action
<p>The LCD will toggle between these 2 screens:</p> <div style="border: 1px solid black; padding: 5px; margin-bottom: 10px;"> <p>RADIO SETTINGS BCAST X CHAN YY</p> </div> <div style="border: 1px solid black; padding: 5px; margin-bottom: 10px;"> <p>ENTER TO ACCEPT CLEAR TO MODIFY</p> </div> <div style="border: 1px solid black; padding: 5px;"> <p>BCAST GROUP X* RADIO CHAN YY</p> </div> <p>X = broadcast group number YY = channel number</p>	<p>The LCD shows the current radio settings along with a prompt to accept or modify these values.</p> <p>If the radio settings are correct press <b>&lt;ENTER&gt;</b>.</p> <p>If these values are incorrect, press <b>&lt;CLEAR&gt;</b>, and the LCD at bottom left is shown, allowing edit of the channel or broadcast group setting.</p> <p><b>Broadcast Group Setting</b>  <b>[1]</b> Use this setting for all multiple controllers with single broadcast group setups. Use the number keys to edit this value and press <b>&lt;ENTER&gt;</b> to accept. The asterisk will move to the channel setting.</p> <p><b>Channel Setting</b>  <b>[1-8]</b> Edit the channel number to the desired value and press <b>&lt;ENTER&gt;</b> to accept. The CHAN switch on the receiver must match this value.</p>

# Multiple Controller with Multiple Broadcast Groups

## Reference Drawings:

System Riser: Gen V or VI Mult. Broadcast/Channel Groups ..... **DWG-202943**

In a multiple controller system with multiple broadcast groups (**Figure 6**), there are many consoles that control multiple scoreboards and/or scoreboard groups. The radio receiver inside the scoreboard is set to broadcast group 1–8. By changing the console settings to the specific broadcast group address, a single console can control all scoreboards or specific groups of scoreboards. One example of this scenario is split court operation in basketball installations, where scoreboards are used to score multiple games at once, but can be grouped together to show one game if necessary. Refer to **DWG-202943**.

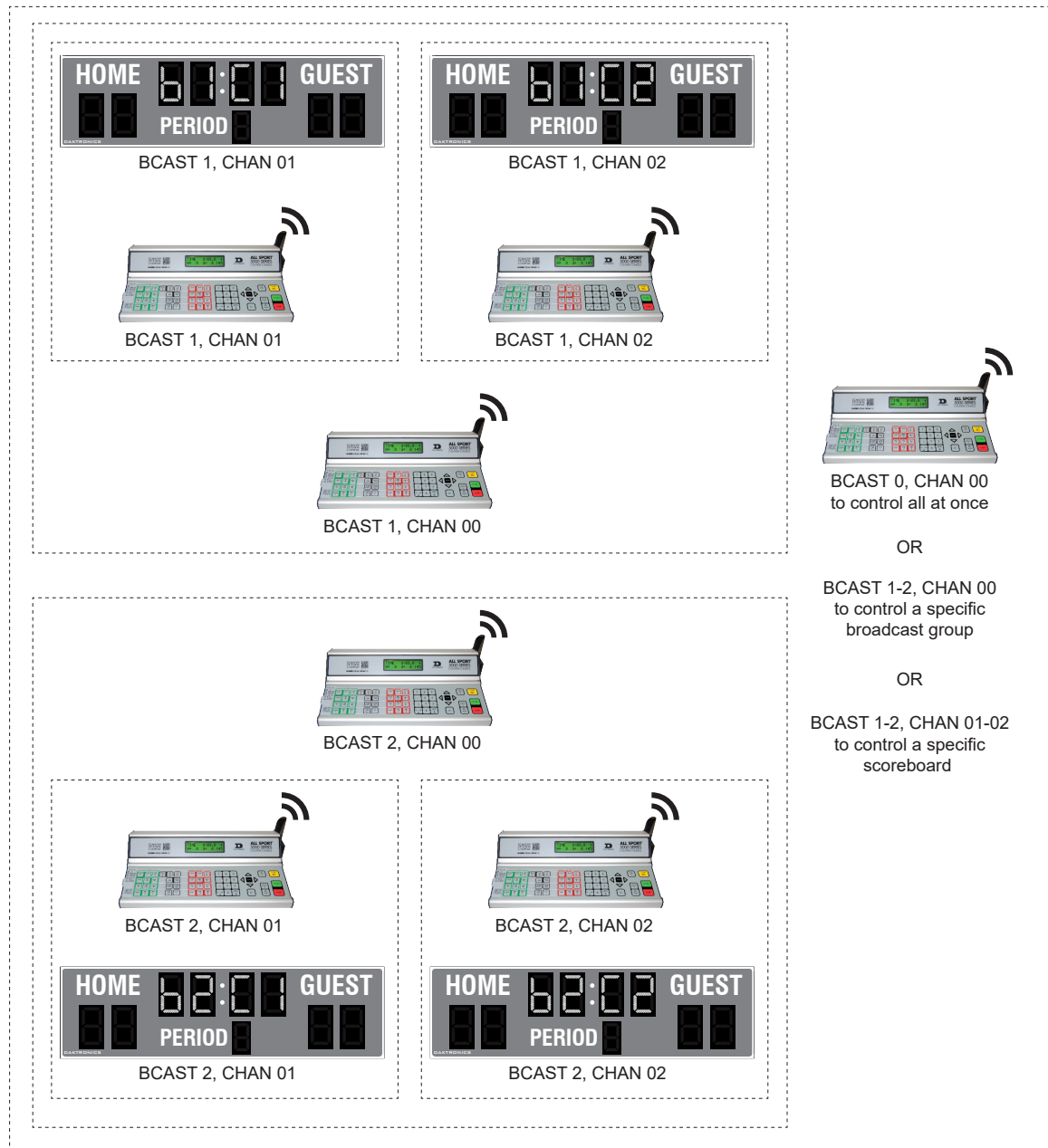

**Figure 6:** Multiple Broadcast Group

Typically, all multiple controller systems will use BCAST 1, CHAN 1 for the first controller in Broadcast Group 1 and BCAST 2, CHAN 1 for the first controller in Broadcast Group 2. All other consoles in a group are added sequentially.

## Setting Radio Channels

Display	Action																			
<p>The LCD will toggle between these 2 screens.</p> <div style="border: 1px solid black; padding: 5px; margin-bottom: 10px;"> RADIO SETTINGS  BCAST X CHAN YY </div> <div style="border: 1px solid black; padding: 5px; margin-bottom: 10px;"> ENTER TO ACCEPT  CLEAR TO MODIFY </div> <div style="border: 1px solid black; padding: 5px;"> BCAST GROUP X*  RADIO CHAN YY </div> <p>X = broadcast group number  YY = channel number</p>	<p>The LCD shows the current radio settings along with a prompt to accept or modify these values.</p> <p>If the radio settings are correct press <b>&lt;ENTER&gt;</b>.</p> <p>If these values are incorrect, press <b>&lt;CLEAR&gt;</b>, and the LCD at bottom left is shown, allowing edit of the channel or broadcast group setting.</p> <p>Use the number keys to enter the desired broadcast group and press <b>&lt;ENTER&gt;</b> to accept. The asterisk will move to the channel setting.</p> <p>Edit the channel number to the desired value and press <b>&lt;ENTER&gt;</b> to accept.</p> <table border="1" data-bbox="678 745 1409 1157"> <thead> <tr> <th>Broadcast Group</th> <th>Channel Setting</th> <th>Control Scoreboards</th> </tr> </thead> <tbody> <tr> <td>0</td> <td>0</td> <td>All Scoreboards</td> </tr> <tr> <td rowspan="2">1</td> <td>0</td> <td>All in BCAST Group 1</td> </tr> <tr> <td>1-8</td> <td>Set to corresponding BCAST 1 Channel</td> </tr> <tr> <td style="text-align: center;">↓</td> <td style="text-align: center;">↓</td> <td style="text-align: center;">↓</td> </tr> <tr> <td rowspan="2">8*</td> <td>0</td> <td>All in BCAST Group 8</td> </tr> <tr> <td>1-8</td> <td>Set to corresponding BCAST 8 Channel</td> </tr> </tbody> </table> <p>* Gen VI radio receivers sold internationally have only 4 groups.</p>	Broadcast Group	Channel Setting	Control Scoreboards	0	0	All Scoreboards	1	0	All in BCAST Group 1	1-8	Set to corresponding BCAST 1 Channel	↓	↓	↓	8*	0	All in BCAST Group 8	1-8	Set to corresponding BCAST 8 Channel
Broadcast Group	Channel Setting	Control Scoreboards																		
0	0	All Scoreboards																		
1	0	All in BCAST Group 1																		
	1-8	Set to corresponding BCAST 1 Channel																		
↓	↓	↓																		
8*	0	All in BCAST Group 8																		
	1-8	Set to corresponding BCAST 8 Channel																		

### 3 Troubleshooting

If a problem occurs that is not listed in the following section or that cannot be resolved, contact Daktronics using the information provided in **Section 4: Daktronics Exchange and Repair & Return Programs (p.14)**.

#### Blank Scoreboard(s)

- Ensure the console with Gen VI radio installed is ON and set to the correct Sport Code for the scoreboard model.
- Ensure the console is set to the same Broadcast and Channel number as the scoreboard.
- Verify the **STATUS** and **POWER** indicators on the back of the console are ON solid.
- Verify an antenna is connected to both the console and the scoreboard, pointing straight up, and showing no signs of damage or deformity.

After verifying all of the above points, set the console to BCAST 0, CHAN 0 (it may take up to 30 seconds for a scoreboard to link to the server).

- If the scoreboard works with these settings, cycle power to the scoreboard and look for "b# C#", then set the console to the same broadcast and channel numbers.
  - If the console set to the exact channel still does not work, it may be interference – try setting a new channel on both the scoreboard receiver and console.
- If the scoreboard does not work with these settings, try the following if possible:
  - Move the console within 20' (6.1 m) of the scoreboard. If it starts to work at this distance, this can indicate a problem with interference or the antenna(s).
  - Use the same console on another scoreboard, or use another console on the same scoreboard. If the console works with another scoreboard, the radio receiver in the original scoreboard may need to be replaced; if a different console works with the same scoreboard, the original console may need to be replaced.

#### Skipping, Periodic Blanking & Delays on Scoreboard(s)

These behaviors are typically due to low signal strength or interference from excessive use of wireless devices in the area. Follow the guidelines below to ensure optimal operating conditions of the radio system:

- Verify an antenna is connected to both the console and the scoreboard, pointing straight up, and showing no signs of damage or deformity.
- Ensure there is no more than 500' (152 m) indoor or 1500' (457 m) outdoor between the console and the scoreboard. At the same time, ensure the minimum separation between a console antenna and scoreboard antenna is greater than 20' (6.1 m).
- Ensure there is direct line-of-sight between the radio antennas. Obstacles that may interfere with radio waves:
  - Chain link fence
  - Concrete or metal structures
  - Tinted & "Low-E" Glass\*
  - Weather, such as fog and rain
  - Trees
  - Crowds (standing in front of console)

\* **Energy-efficient glass windows can significantly reduce effective signal range.**

- If more than one console is being used in the facility, they will never be set to the same BCAST and CHAN numbers at once. Also, keep the consoles at least 20' (6.1 m) apart.
- Verify Wi-Fi hotspots and cellular repeaters are kept as far as possible from both the console and the scoreboard.

## Radio Diagnostics

Both the transmitter and receiver radios must have at least **Version 1.3** firmware to perform diagnostic tests. The All Sport 5000 console must be at least **Version 4.0.9** to access test menus.

### Identifying Radios with Diagnostic Support

- **Transmitter Radio (Console):** If the transmitter radio supports diagnostic features, the All Sport 5000 console will allow access to the "RADIO TEST" menu option. The console will not allow access to this menu if the transmitter radio does not support diagnostics.
- **Receiver Radio (Scoreboard):** If the scoreboard responds to an All Sport 5000 console running a diagnostics test, then the receiver will support basic diagnostics at a minimum. Further support can be identified by running the "SERVER VER" radio test and recording the receiver radio firmware version displayed on the scoreboard.

**If the radio system supports diagnostics and enters/ displays information on the scoreboard, then both radios are functioning properly.** If the scoreboard does not respond to an All Sport 5000 console running a diagnostics test (remains blank), access to the receiver radio may be required to troubleshoot further.

With power disconnected from the scoreboard, access the radio enclosure and remove the cover to expose the receiver radio circuit board. A white sticker, as shown in **Figure 7**, will provide a visual indication of the radio firmware version.

The first two numbers on the sticker indicate the firmware version. This number must be "1.3" or higher to support radio diagnostics.



**Figure 7:** Radio Firmware Version Label

### Radio Test Menus

The tests provided are designed to gather as much data about the radio operation as possible to help diagnose radio communication problems. These test menus are also described in the **Radio Diagnostics** section of the **All Sport 5000 Series Control Console Operation Manual (ED-11976)**, available online at [www.daktronics.com/manuals](http://www.daktronics.com/manuals).

Display	Action
<div data-bbox="297 212 630 296" style="border: 1px solid black; padding: 2px; margin-bottom: 5px;">MENU- MAIN ENTER DISPLAY MENU?</div> <div data-bbox="297 331 630 415" style="border: 1px solid black; padding: 2px; margin-bottom: 5px;">MENU-DISPLAY RADIO TEST?</div> <div data-bbox="297 451 630 535" style="border: 1px solid black; padding: 2px;">EXIT GAME ARE YOU SURE?</div>	<p>After the main clock has been stopped, press the <b>&lt;MENU&gt;</b> key and press the down or up arrows until the LCD at top left is displayed. Press <b>&lt;ENTER&gt;</b> to enter the display menu.</p> <p>Press the down or up arrows until the LCD at center left is displayed. Press <b>&lt;ENTER&gt;</b> to exit the current game in progress and enter the radio diagnostics menu.</p> <p><b>Note:</b> The console will prompt to press <b>&lt;ENTER&gt;</b> a second time to avoid accidental exit from the sport program.</p>
<div data-bbox="297 615 630 699" style="border: 1px solid black; padding: 2px; margin-bottom: 5px;">RADIO TEST -SIGNAL LEVEL</div> <div data-bbox="297 735 630 819" style="border: 1px solid black; padding: 2px;">SIGNAL LEVEL ANY KEY TO EXIT</div>	<p>Press <b>&lt;ENTER&gt;</b> to begin the signal level test, or press the down or up arrows to select another test.</p> <p>This test sends a command to the radio receiver in the scoreboard to show its signal level on the first 2 clock digits*. The signal level can range from '00' (weakest) to '99' (strongest). The value of '00' would indicate there is no server in range. For scoreboards with 4-digit clocks, the 2 right clock digits* will also show the missed packet count during this test (see section below). Press any key to exit the test.</p>
<div data-bbox="297 972 630 1056" style="border: 1px solid black; padding: 2px; margin-bottom: 5px;">RADIO TEST -MISSED PACKET</div> <div data-bbox="297 1092 630 1176" style="border: 1px solid black; padding: 2px;">MISSED PACKET ANY KEY TO EXIT</div>	<p>Press <b>&lt;ENTER&gt;</b> to begin the missed packet test, or press the down or up arrows to select another test.</p> <p>This test sends a command to the radio receiver in the scoreboard to show the number of missed packets on the first 2 clock digits*. The missed packet count ranges from '00' to '99' and indicates the number of missed packets since the start of the test. Ideally, the number should be '00' to indicate no missing packets. A larger number indicates that there are some signal issues, either with signal level or noise interference. For scoreboards with 4-digit clocks, the 2 right clock digits* will also show the signal level during this test (see previous section). Press any key to exit the test.</p>
<div data-bbox="297 1318 630 1402" style="border: 1px solid black; padding: 2px; margin-bottom: 5px;">RADIO TEST -RADIO CHAN</div> <div data-bbox="297 1438 630 1522" style="border: 1px solid black; padding: 2px;">BCAST X CHAN Y ANY KEY TO EXIT</div> <p data-bbox="297 1539 557 1591">X = broadcast number Y = channel number</p>	<p>Press <b>&lt;ENTER&gt;</b> to begin the radio channel test, or press the down or up arrows to select another test.</p> <p>This test shows the current Broadcast Group and Channel number settings in the console. This test also sends a command to the radio receiver in the scoreboard to show the receiver's settings on the first 2 clock digits* by alternating between "bX" and "CY", where X is the current Broadcast Group and Y is the current Channel. Use this menu to verify the console and scoreboard radio settings. Press any key to exit the test.</p>
<div data-bbox="297 1644 630 1728" style="border: 1px solid black; padding: 2px; margin-bottom: 5px;">RADIO TEST -SERVER VER</div> <div data-bbox="297 1764 630 1848" style="border: 1px solid black; padding: 2px;">SERVER VER X.Y ANY KEY TO EXIT</div> <p data-bbox="297 1864 610 1917">X = firmware major number Y = firmware minor number</p>	<p>Press <b>&lt;ENTER&gt;</b> to begin the server test, or press the down or up arrows to select another test.</p> <p>This test shows the console's radio firmware version number. This test also sends a command to the radio receiver in the scoreboard to show the receiver's firmware version number on the first 2 clock digits* by alternating between "rX" and "_Y", where _ is a blank digit. For example, version 1.3 would display as "r1" followed by "_3". Press any key to exit the test.</p>

Display	Action
	Press <ENTER> to exit the radio diagnostics menu and return to the SELECT CODE prompt.

\* Location of information displayed will vary on scoreboards without clocks.

### Signal Strength & Missed Packet Tests

If the radio system has been set up in accordance with **Section 2: Setting Radio Channels (p.2)**, the radio system should receive all data packets with no missed or corrupted data. In addition, the signal strength should be as high as possible.

Testing has shown indoor installations should be in the upper 90's for strength. Outdoor installations may show slightly lower strength due to increased distances between radios and radios not being positioned within direct line-of-sight.

Any packet loss and/or lower signal strength indicates a potential problem with the antenna and feeder cable components of the radio, high blockage of radio signal path, or the presence of RF interference in the immediate area.

**Note:** It is possible to see high signal strength with data packet loss. The signal strength is an averaged value over many received packets. Missed packets do not report a signal strength value and are not included in the calculations.

### Radio Channel Test

This test will indicate the Broadcast Group and Channel settings of the console transmitter radio on the LCD and display the current receiver radio Broadcast Group and Channel settings on the scoreboard. Use this test to quickly identify receiver settings without cycling power to the scoreboard or physically accessing the receiver radio.

### Server Version Test

This test will indicate the firmware version of the console transmitter radio on the LCD as well as display the receiver radio firmware version on the scoreboard. This test is used to determine supported diagnostic features and provide important information to the Daktronics Help Desk for in-depth troubleshooting.

## Additional Information

**Running Diagnostics:** An All Sport 5000 console running a diagnostics test behaves similarly to operation on the Master Broadcast channel. All unconnected receiver radios within range will detect and switch to diagnostics mode if they support it. These receivers will remain in diagnostics mode until the console exits the test mode or is powered down. The receivers will return to normal operation after a short time.

**Note:** Any receiver currently connected to and being operated by a different console will not be affected. For example, if one scoreboard is being tested but another is needed for a game, the test mode must be exited so the scoreboard not under test may connect to a console. Testing may then resume for the other scoreboard.



**Loss of Server while testing:** If the transmitter radio is no longer detected by a receiver (due to excessive signal loss/interference), the receiver will wait for 10 seconds before returning to normal operation. During this time, the display will blank the first two clock digits, and put "00" on the second two clock digits.

**Note:** Location of information displayed will vary on scoreboard without clocks.

**Scoreboard with LED clock colon:** While running the tests, a receiver radio will periodically flash the decimal indicator to denote an active running test. For instance, if the data packet/signal strength values aren't changing on the scoreboard, the flashing decimal helps verify the test is still running and the radios haven't disconnected.

## 4 Daktronics Exchange and Repair & Return Programs

### Exchange Program

The Daktronics Exchange Program is a service for quickly replacing key components in need of repair. If a component fails, Daktronics sends a replacement part to the customer who, in turn, returns the failed component to Daktronics. This decreases equipment downtime. Customers who follow the program guidelines explained below will receive this service.

Before contacting Daktronics, identify these important numbers:

**Display Serial Number:** \_\_\_\_\_

**Display Model Number:** \_\_\_\_\_

**Job/Contract Number:** \_\_\_\_\_

**Date Manufactured/Installed:** \_\_\_\_\_

**Daktronics Customer ID Number:** \_\_\_\_\_

To participate in the Exchange Program, follow these steps:

**1. Call Daktronics Customer Service.**

Market Description	Customer Service Number
Schools (including community/junior colleges), religious organizations, municipal clubs, and community centers	877-605-1115 Fax: 605-697-4444
Universities and professional sporting events, live events for auditoriums, and arenas	866-343-6018 Fax: 605-697-4444

**2. When the new exchange part is received, mail the old part to Daktronics.**

If the replacement part fixes the problem, send in the problem part being replaced.

- a. Package the old part in the same shipping materials in which the replacement part arrived.
- b. Fill out and attach the enclosed UPS shipping document.
- c. Ship the part to Daktronics.

**3. The defective or unused parts must be returned to Daktronics within 5 weeks of initial order shipment.**

If any part is not returned within five (5) weeks, a non-refundable invoice will be presented to the customer for the costs of replenishing the exchange parts inventory with a new part. Daktronics reserves the right to refuse parts that have been damaged due to acts of nature or causes other than normal wear and tear.

## Repair & Return Program

For items not subject to exchange, Daktronics offers a Repair & Return Program. To send a part for repair, follow these steps:

1. **Call or fax Daktronics Customer Service.** Refer to the appropriate number in the chart on the previous page.
2. **Receive a case number before shipping.** This expedites repair of the part.
3. **Package and pad the item carefully to prevent damage during shipment.** Electronic components, such as printed circuit boards, should be placed in an antistatic bag before boxing. Daktronics does not recommend using packing peanuts when shipping.
4. **Enclose:**
  - name
  - address
  - phone number
  - the case number
  - a clear description of symptoms
5. **Ship to:**

Daktronics Customer Service  
[Case #]  
201 Daktronics Drive, Dock E  
Brookings, SD 57006

## Daktronics Warranty & Limitation of Liability

The Daktronics Warranty & Limitation of Liability is located at the end of this manual. The Warranty is independent of Extended Service agreements and is the authority in matters of service, repair, and display operation.

*This page intentionally left blank.*

# A Reference Drawings

Any contract-specific drawings take precedence over the general drawings.

## Reference Drawings:

Install Details; Indoor Radio/Wire Switch .....	<b>DWG-168045</b>
System Riser: Gen V or VI Mult. Broadcast/Channel Groups .....	<b>DWG-202943</b>
Installation Diagram; Indoor Scbd Gen VI Radio Receiver .....	<b>DWG-1109105</b>
Installation Drawing; Outdoor Scbd Gen VI Radio Receiver .....	<b>DWG-1109181</b>
Outdoor Installation; Gen VI Radio & Base Station .....	<b>DWG-1109252</b>
Radio Installation Details; Scoreboards .....	<b>DWG-1130990</b>
Radio Installation Pattern; Scoreboards .....	<b>DWG-1166771</b>

*This page intentionally left blank.*

INSTALLATION STEPS:

1. TURN POWER OFF TO THE SCOREBOARD.
2. LOCATE THE PANEL ON THE SCOREBOARD THAT HAS THE DRIVER TRAY BEHIND IT AND OPEN. ATTACH SNAP TRACK TO BACKSHEET WITHIN 1" OF DRIVER USING THE DOUBLE SIDED TAPE PRE-INSTALLED ON BACK OF SNAP TRACK. SNAP WIRE/RADIO SWITCH CARD INTO SNAP TRACK JUST INSTALLED.
3. CONNECT POWER TO RADIO/WIRE SWITCH CARD.
  - 3.1 LOCATE 5 PIN PLUG (P45) THAT CONNECTS THE RADIO RECEIVER TO THE DRIVER TRAY.
  - 3.2 DISCONNECT THE RADIO RECEIVER.
  - 3.3 CONNECT POWER HARNESS INCLUDED WITH RADIO/WIRE SWITCH KIT TO THE 5 PIN JACK (J45) ON THE DRIVER TRAY.
  - 3.4 CONNECT THE 2 PIN END OF HARNESS JUST INSTALLED TO THE RADIO/WIRE SWITCH CARD J1 (POWER).
4. REROUTE SIGNAL INTO THE WIRE/RADIO SWITCH CARD JUST INSTALLED.
  - 4.1 USE A SCREWDRIVER TO LOOSEN THE SCREWS ON THE SIGNAL TERMINAL BLOCK ON THE DRIVER TRAY, TB31-1&2 (RED AND BLK WIRES). THESE ARE THE WIRES THAT COME FROM THE 1/2" PHONE JACK ON THE OUTSIDE OF THE SCOREBOARD.
  - 4.2 MOVE WIRES JUST REMOVED FROM THE DRIVER TRAY TO THE SIGNAL IN TERMINAL BLOCK (TB1) ON THE RADIO/WIRE SWITCH CARD. RED IS CONNECT TO + AND BLACK IS CONNECTED TO -.
  - 4.3 INSTALL THE JUMPER WIRE INCLUDED WITH THE RADIO/WIRE SWITCH KIT FROM THE SIGNAL OUT TERMINAL BLOCK (TB2) ON THE RADIO/WIRE SWITCH CARD (RED +, BLACK -) TO THE DRIVER TRAY TB31 (RED TB31-1, BLACK TB31-2).
5. CONNECT 5 PIN PLUG (P45) FROM RADIO RECEIVER TO J2 (RADIO) ON THE WIRE/RADIO SWITCH CARD.
6. DOUBLE CHECK ALL CONNECTIONS TO BE SURE SYSTEM IS CONNECTED PROPERLY AND THAT ALL CONNECTIONS ARE TIGHT.
7. CLOSE SCOREBOARD PANEL.
8. TURN POWER BACK ON TO SCOREBOARD AND TEST.

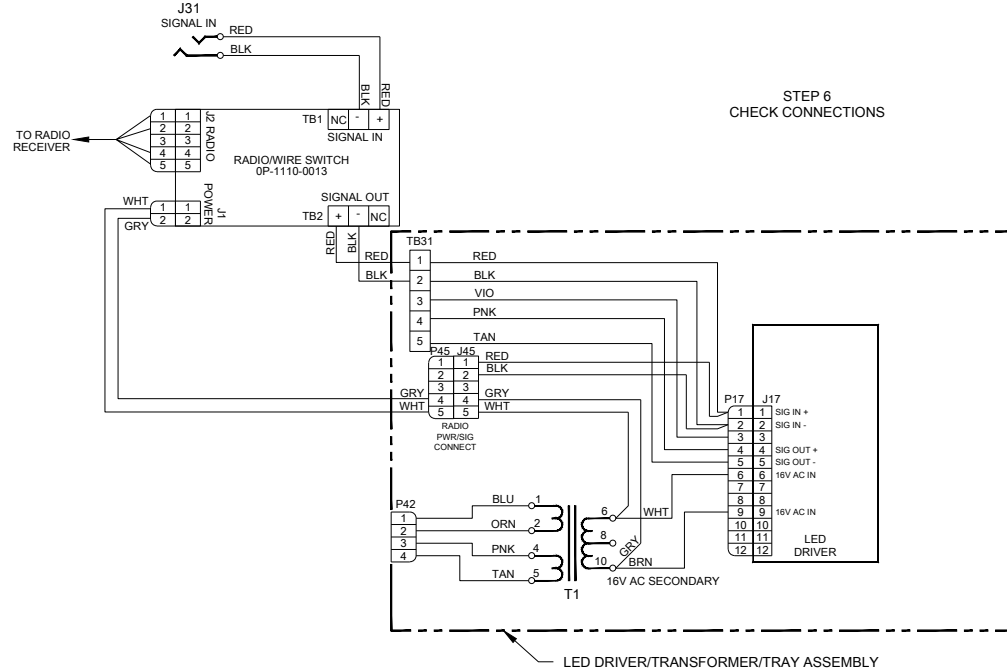
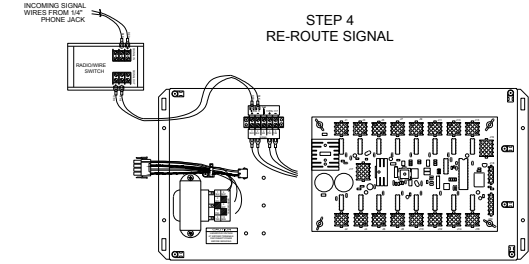
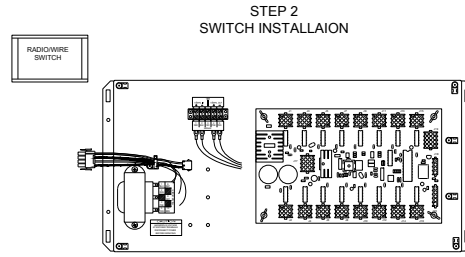

<b>DAKTRONICS, INC.</b> BROOKINGS, SD 57006		THE CONCEPTS EXPRESSED AND DETAILS SHOWN ON THIS DRAWING ARE CONFIDENTIAL AND PROPRIETARY. DO NOT REPRODUCE BY ANY MEANS WITHOUT THE EXPRESSED WRITTEN CONSENT OF DAKTRONICS, INC. COPYRIGHT 2012 DAKTRONICS, INC.	
DO NOT SCALE DRAWING			
PROJ: STANDARD INDOOR LED SCOREBOARDS			
TITLE: INSTALL DETAILS: INDOOR RADIO/WIRE SWITCH			
DESIGN:	DRAWN: CBRECZI	DATE: 03 JUN 02	
SCALE: 1=1			
SHEET	REV	JOB NO.	FUNC-TYPE-SIZE
	01	1152	E-01-B
			<b>168045</b>

REV	DATE	ADJUSTED WIRE CONNECTIONS TO SECONDARY SIDE OF 16VAC XNSFMFR PER EC-8255.	BY
01	13 NOV 12		SMB

REV 01  
 DATE: 07 AUG 12  
 UPDATED TITLE NAME TO INCLUDE VI RADIO  
 ADDED TEXT TO THE RISER TO SAY V OR VI  
 BY: MWM

PROJ: ALL SPOT RADIO  
 TITLE: SYSTEM RISER GEN V OR VI MULT. BROADCAST/CHANNEL GROUPS  
 DESIGN: MILLER  
 DRAWN: RTAGTOW  
 SCALE: NONE  
 SHEET: 01  
 REV: P 1 10  
 JOB NO: R-01-A  
 FUNC-TYPE-SIZE: 202943  
 DATE: 21 JAN 04

**DAKTRONICS, INC.**  
 BROOKINGS, SD 57006  
 DO NOT SCALE DRAWING  
 THE CONCEPTS EXPRESSED AND DETAILS SHOWN ON THIS DRAWING ARE CONFIDENTIAL AND PROPRIETARY. DO NOT REPRODUCE BY ANY MEANS WITHOUT THE EXPRESSED WRITTEN CONSENT OF DAKTRONICS, INC. COPYRIGHT 2012 DAKTRONICS, INC.

THIS RISER LAYOUT IS FOR AN ALL GEN V RADIO SYSTEM OR AN ALL GEN VI RADIO SYSTEM.

ONE CONSOLE SET TO  
 BCAST = 01  
 CHANNEL = 01  
 CONTROLLING SCBD #1 ONLY



SCBD #1

SCOREBOARD  
 WITH RADIO SET  
 TO BCAST = 01  
 CHANNEL = 01

ONE CONSOLE SET TO  
 BCAST = 02  
 CHANNEL = 01  
 CONTROLLING SCBD #3 ONLY

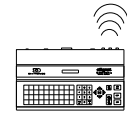

SCBD #3

SCOREBOARD  
 WITH RADIO SET  
 TO BCAST = 02  
 CHANNEL = 01

ONE CONSOLE SET TO  
 BCAST = 03  
 CHANNEL = 01  
 CONTROLLING SCBD #5 ONLY

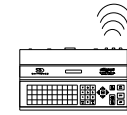

SCBD #5

SCOREBOARD  
 WITH RADIO SET  
 TO BCAST = 03  
 CHANNEL = 01

COURT #1 CONTROL

ONE CONSOLE SET TO  
 BCAST = 01  
 CHANNEL = 00  
 CONTROLLING  
 SCOREBOARDS #1&2

COURT #2 CONTROL

ONE CONSOLE SET TO  
 BCAST = 02  
 CHANNEL = 00  
 CONTROLLING  
 SCOREBOARDS #3&4

COURT #3 CONTROL

ONE CONSOLE SET TO  
 BCAST = 03  
 CHANNEL = 00  
 CONTROLLING  
 SCOREBOARDS #5&6

MAIN COURT CONTROL

ONE CONSOLE SET TO  
 BCAST = 00  
 CHANNEL = 00  
 CONTROLLING  
 SCOREBOARDS #1-6

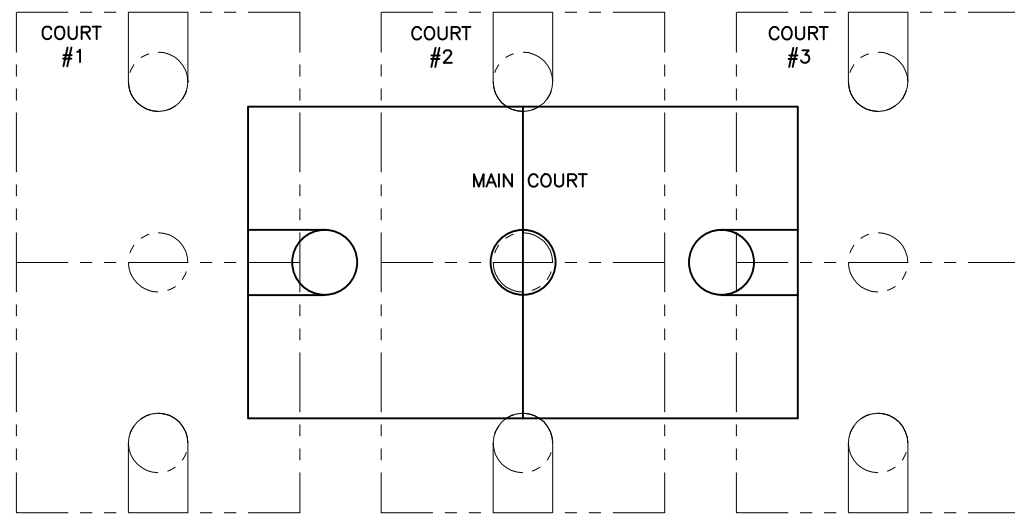

SCBD #2

SCOREBOARD  
 WITH RADIO SET  
 TO BCAST = 01  
 CHANNEL = 02



ONE CONSOLE SET TO  
 BCAST = 01  
 CHANNEL = 02  
 CONTROLLING SCBD #2 ONLY

SCBD #4

SCOREBOARD  
 WITH RADIO SET  
 TO BCAST = 02  
 CHANNEL = 02



ONE CONSOLE SET TO  
 BCAST = 02  
 CHANNEL = 02  
 CONTROLLING SCBD #4 ONLY

SCBD #6

SCOREBOARD  
 WITH RADIO SET  
 TO BCAST = 03  
 CHANNEL = 02



ONE CONSOLE SET TO  
 BCAST = 03  
 CHANNEL = 02  
 CONTROLLING SCBD #6 ONLY

NOTE: THIS CONFIGURATION IS ONLY COMPATIBLE WITH GEN V RADIOS



# \*\*INDOOR SCOREBOARDS ONLY\*\*

## RADIO PREPARATION

- RADIO SETTING FROM FACTORY IS F=1, B=1, C=1. IF THIS SETTING IS FINE FOR YOUR FACILITY LAYOUT, INSTALL RADIO INTO DISPLAY.  
OR

OR

OPEN RADIO CASE BY REMOVING 4 PHILIPS HEAD SCREWS. ALWAYS LEAVE FUNCTION = 1, BUT CHANGE THE CHANNEL AND BCASST DIALS AS NEEDED. USE SMALL FLAT HEAD SCREW DRIVER.

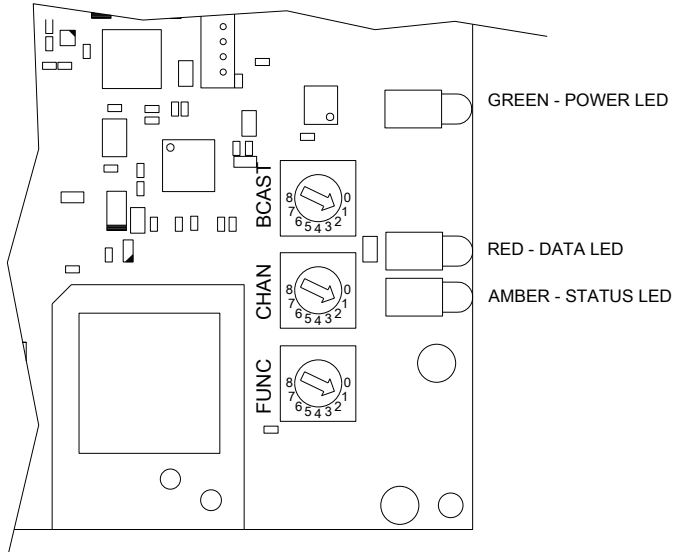

MOUNTING RADIO RECEIVER IN MOST INDOOR SCOREBOARDS. SEE DWG-1130990 FOR RADIO RECEIVER MOUNTING IN SCOREBOARDS MADE AFTER MARCH 2013

ADD RADIO NEXT TO PERIOD DIGIT WHERE POSSIBLE.

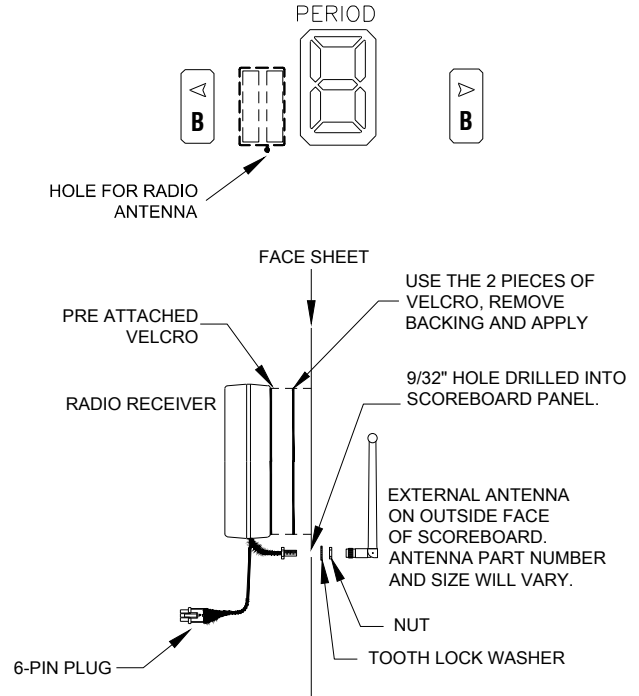

PLUG THE 6-PIN MALE PLUG FROM THE RADIO RECEIVER INTO THE MATING 6-PIN JACK ( J21) ON THE DRIVER PCB AS SHOWN

NOTE:  
LOCATE DRIVER TRAY, TYPICALLY BEHIND HOME SCORE OR THE CLOCK. LOCATION MAY VARY BETWEEN SCOREBOARD MODELS

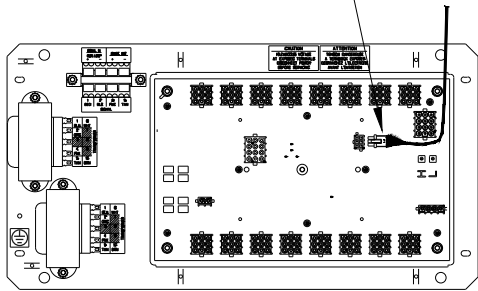

GYRUS VIEW

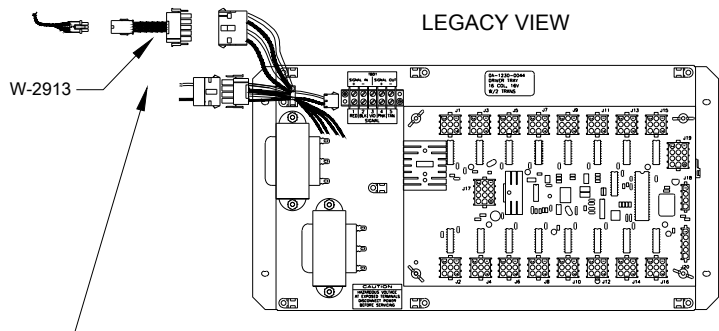

LEGACY VIEW

PLUG THE 6-PIN MALE PLUG FROM THE RADIO RECEIVER INTO THE MATING 6-PIN JACK OF THE ADAPTOR HARNESS (W-2913). PLUG THE MALE 5-PIN END OF THE ADAPTOR HARNESS INTO THE MATING 5-PIN CONNECTOR (J45) COMING FROM THE DRIVER.

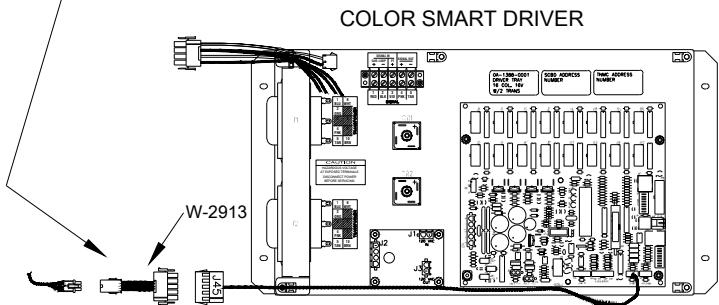

COLOR SMART DRIVER

REV 04	DATE: 15 JAN 15	ROTATED GYRUS DRIVER 180 DEGREES	BY: MTR
REV 03	DATE: 17 FEB 15	ADDED NEW GYRUS TRAYS VIEW SWAPPED PLUG FROM RADIO WITH W-2909 ADDED W-2913 CONNECTOR BETWEEN W-2909 & J45	BY: BJB
REV 02	DATE: 28 MAR 14	PER EC-13907, ADDED INDOOR SCBD ONLY NOTE	BY: KDD
REV 01	DATE: 10 JUL 13	ADDED REFERENCE TO RADIO RECIEVER MOUNTING DRAWING 1130990	BY: KCS

 <b>DAKTRONICS, INC.</b> BROOKINGS, SD 57006 DO NOT SCALE DRAWING		THE CONCEPTS EXPRESSED AND DETAILS SHOWN ON THIS DRAWING ARE CONFIDENTIAL AND PROPRIETARY. DO NOT REPRODUCE BY ANY MEANS WITHOUT THE EXPRESSED WRITTEN CONSENT OF DAKTRONICS, INC. COPYRIGHT 2012 DAKTRONICS, INC.	
PROJ: ALL SPORT RADIO TITLE: INSTALLATION DIAGRAM; INDOOR SCBD GEN VI RADIO RECEIVER			
DESIGN: MMILLER SCALE: NONE		DRAWN: MMILLER DATE: 07 AUG 12	
SHEET	REV	JOB NO:	FUNC-TYPE-SIZE
04	P 1110	F - 01 - A	1109105

# \*\*OUTDOOR SCOREBOARDS ONLY\*\*

## RADIO PREPARATION

- RADIO SETTING FROM FACTORY IS F=1, B=1, C=1. IF THIS SETTING IS FINE FOR YOUR FACILITY LAYOUT, INSTALL RADIO INTO DISPLAY.

OR

OPEN RADIO CASE BY REMOVING 4 PHILIPS HEAD SCREWS. ALWAYS LEAVE FUNCTION = 1, BUT CHANGE THE CHANNEL AND BCST DIALS AS NEEDED. USE SMALL FLAT HEAD SCREW DRIVER.

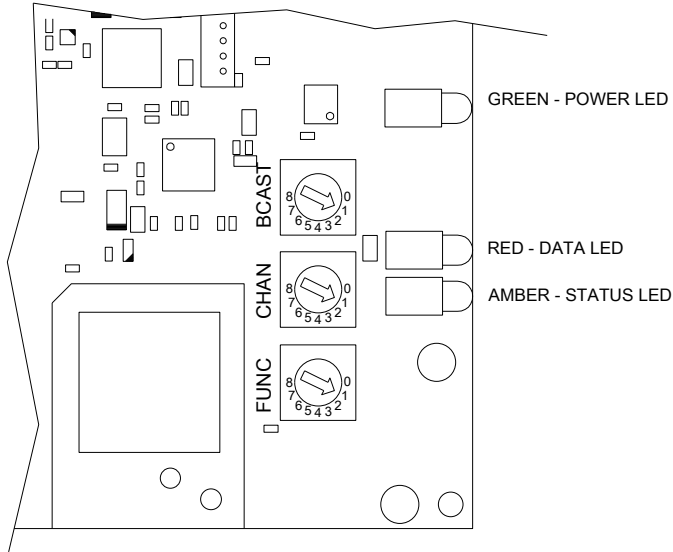

## MOUNTING RADIO RECEIVER IN MOST OUTDOOR SCOREBOARDS.

NEAR THE PRIMARY DRIVER ENCLOSURE WILL BE A RADIO BRACKET BOLTED TO A FACE SHEET. THIS POCKET WILL HOLD THE RADIO RECEIVER AND ALLOW YOU TO ROUTE THE CABLING DOWN AND OVER TO THE DRIVER ENCLOSURE.

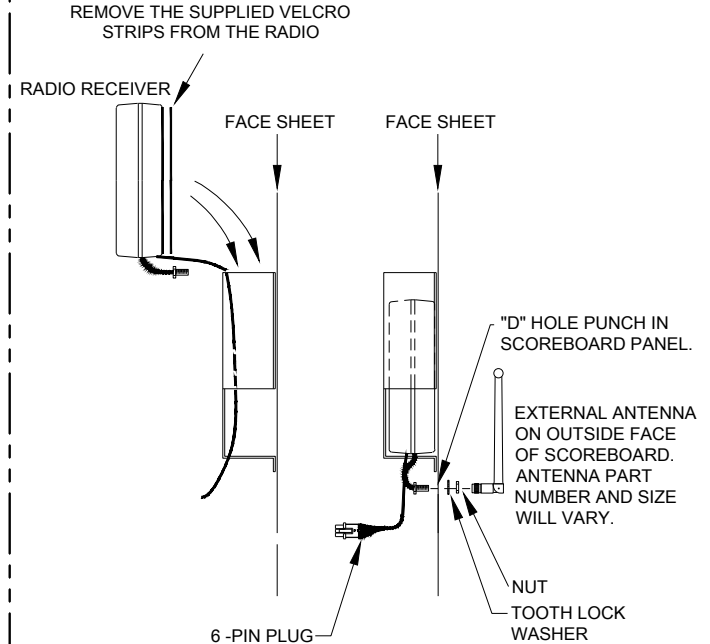

## PRIMARY DRIVER ENCLOSURE, LOCATION VARIES PER SCOREBOARD MODEL.

GYRUS VIEW

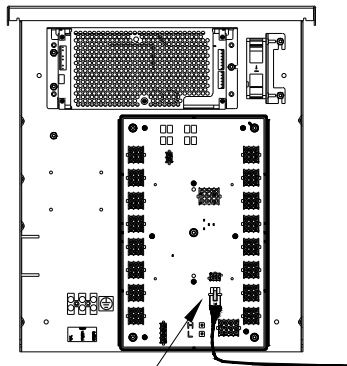

PLUG THE 6-PIN MALE PLUG FROM THE RADIO RECIEVER INTO THE MATING 6-PIN JACK (J21) ON THE DRIVER PCB AS SHOWN.

LEGACY VIEW

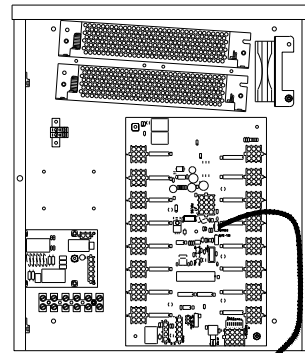

PLUG THE 6-PIN MALE PLUG FROM THE RADIO RECEIVER INTO THE MATING 6-PIN JACK OF THE ADAPTOR HARNESS (W-2913). PLUG THE MALE 5-PIN END OF THE ADAPTER HARNESS INTO THE MATING 5-PIN CONNECTOR (J45) COMING FROM THE DRIVER.

CONNECTOR LABELED "J45"

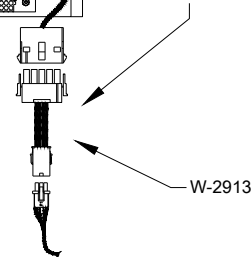

W-2913

REV 03	DATE: 18 FEB 15	ADDED GYRUS VIEW UPDATED RADIO RECEIVER AND LEGACY VIEWS	BY: BJJ
REV 02	DATE: 26 NOV 14	ADDED "REMOVE VELCRO" NOTES	BY: KDD
REV 01	DATE: 27 MAR 14	PER EC-13907, ADDED OUTDOOR SCBD ONLY NOTE	BY: KDD

 <b>DAKTRONICS, INC.</b> BROOKINGS, SD 57006 DO NOT SCALE DRAWING		THE CONCEPTS EXPRESSED AND DETAILS SHOWN ON THIS DRAWING ARE CONFIDENTIAL AND PROPRIETARY. DO NOT REPRODUCE BY ANY MEANS WITHOUT THE EXPRESSED WRITTEN CONSENT OF DAKTRONICS, INC. COPYRIGHT 2012 DAKTRONICS, INC.	
<b>PROJ: ALL SPORT RADIO</b>			
<b>TITLE: INSTALLATION DRAWING; OUTDOOR SCBD GEN VI RADIO RECEIVER</b>			
DESIGN: MMILLER		DRAWN: MMILLER	
SCALE: NONE			
SHEET	REV	JOB NO.	FUNC-TYPE-SIZE
	03	P 1110	F - 01 - A
			1109181

DRAWING USED TO CONNECT TWO RADIOS TO THE SAME DRIVER.

NOTE: THE TWO RECEIVERS SHOULD BE MOUNTED A COUPLE FEET APART  
ONLY ONE WIRELESS CONTROLLER CAN BE USED AT A TIME.

ALLSPORT 2.4GHZ RADIO RECEIVER VIEW

STEP 1  
 REFER TO DWG-01109181 FOR INSTRUCTIONS ON SETTING THE CHANNEL AND MOUNTING INSIDE THE SCOREBOARD

CHANNEL DIAL AND BCAS/CHAN/FUNC DIAL LOCATIONS ON RADIO RECEIVER; COVER REMOVED.

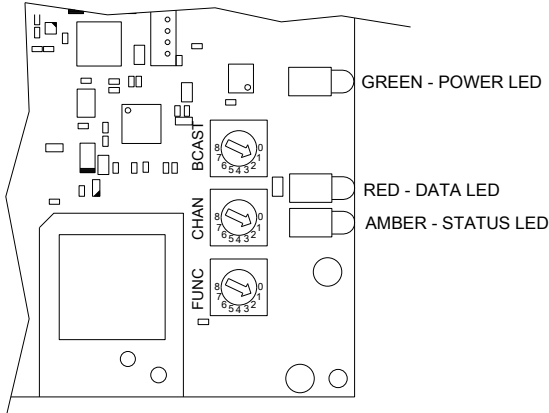

RC-100 BASE STATION VIEW

STEP 1  
 REFER TO DWG-00236394 FOR INSTRUCTIONS ON SETTING THE CHANNEL AND MOUNTING INSIDE THE POWER/SIGNAL ACCESS DOOR.

\*\*SECOND 9/32" HOLE WILL NEED TO BE DRILLED INTO SCOREBOARD FRONT PANEL TO ATTACH THE SECOND ANTENNA

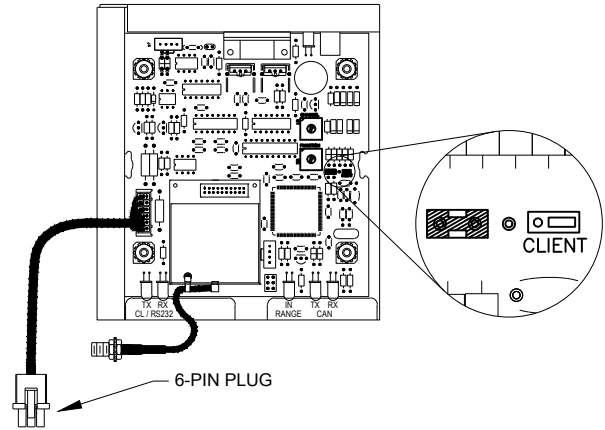

CONNECTING THE RC-100 BASE STATION AND THE ALLSPORT 2.4GHZ RADIO RECEIVER WIRE HARNESSES  
 FRONT VIEW OF DRIVER ENCLOSURE; LID REMOVED

- PLUG THE 6-PIN MALE END OF THE RADIO SPLITTER CABLE (W-2914) INTO THE MATING 6-PIN JACK (J21) ON THE DRIVER.

- PLUG THE 6 PIN MALE PLUGS FROM BOTH THE RECEIVER AND THE BASE STATION INTO THE MATING 6-PIN JACKS OF THE RADIO SPLITTER. IT DOES NOT MATTER WHICH PLUG CONNECTS TO WHICH JACK.

-RC-100 BASE STATION REQUIRES FIRMWARE VERSION 3.7 OR GREATER.

-GEN VI RADIO RECEIVER REQUIRES FIRMWARE VERSION 1.4 OR GREATER.

- PLUG THE 6-PIN MALE PLUG FROM THE RADIO RECEIVER INTO THE MATING 6-PIN JACK OF AN ADAPTOR HARNESS (W-2913).

- PLUG THE MALE 5-PIN END OF THE ADAPTOR HARNESS INTO THE MATING 5-PIN CONNECTOR (J45) COMING FROM THE DRIVER. VERIFY THE OTHER END OF THIS J45 HARNESS IS CONNECTED TO THE J21 (RADIO) ON THE DRIVER.

- ADD A SECOND J45 HARNESS (0A-1388-0004) AND CONNECT THE 4-PIN PLUG END TO THE J22 (RC-100) ON THE DRIVER.

- PLUG THE 6-PIN MALE PLUG FROM THE BASE STATION INTO THE MATING 6-PIN JACK OF ANOTHER ADAPTER HARNESS (W-2913).

- PLUG THE MALE 5-PIN END OF THE ADAPTOR HARNESS INTO THE 5-PIN CONNECTOR (J45) THAT WAS JUST INSTALLED ON THE DRIVER.

GYRUS VIEW

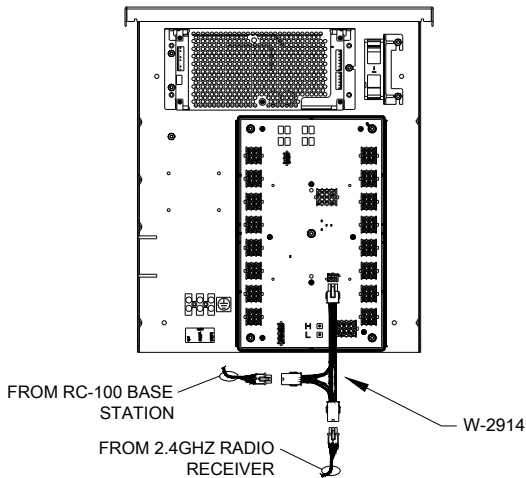

LEGACY VIEW

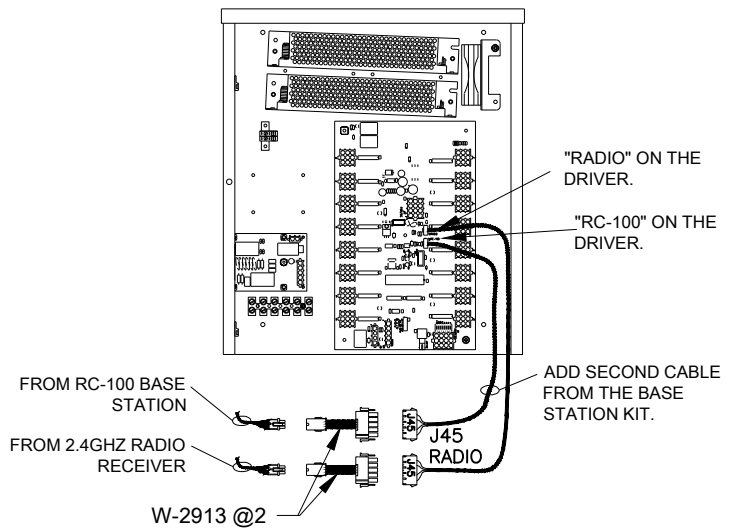

		<b>DAKTRONICS, INC.</b> BROOKINGS, SD 57006 DO NOT SCALE DRAWING		THE CONCEPTS EXPRESSED AND DETAILS SHOWN ON THIS DRAWING ARE CONFIDENTIAL AND PROPRIETARY. DO NOT REPRODUCE BY ANY MEANS WITHOUT THE EXPRESSED WRITTEN CONSENT OF DAKTRONICS, INC. COPYRIGHT 2012 DAKTRONICS, INC.	
PROJ: ALL SPORT RADIO / RC-100 TITLE: OUTDOOR INSTALLATION; GEN VI RADIO & BASE STATION					
DESIGN: MMILLER SCALE: NONE		DRAWN: MMILLER		DATE: 08 AUG 12	
SHEET 02	REV 02	JOB NO: P1110	FUNC-TYPE-SIZE F-01-A	<b>1109252</b>	

REV 02	DATE: 3 SEP 15	ADDED RC-100 AND GEN VI FIRMEARE NOTES	BY: MTR
REV 01	DATE: 18 FEB 15	ADDED GYRUS VIEW UPDATED CONNECTORS FOR LEGACY VIEW	BY: BJG

# \*\*INDOOR SCOREBOARDS ONLY\*\*

## ANTENNA INSTALLATION DETAIL

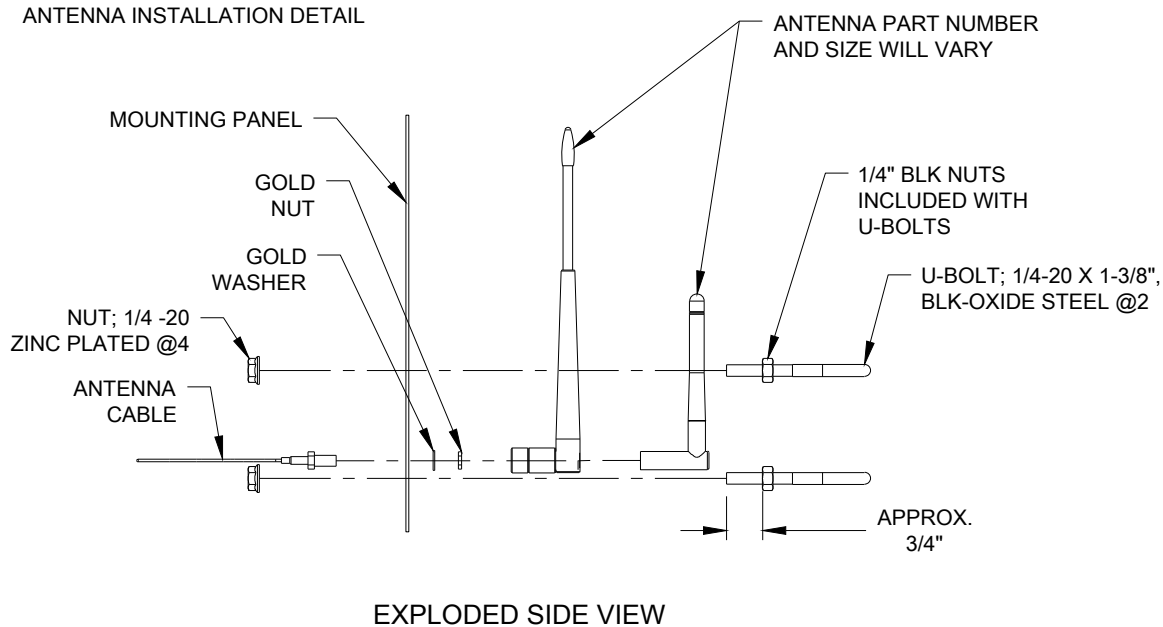

## INSTALLATION INSTRUCTIONS:

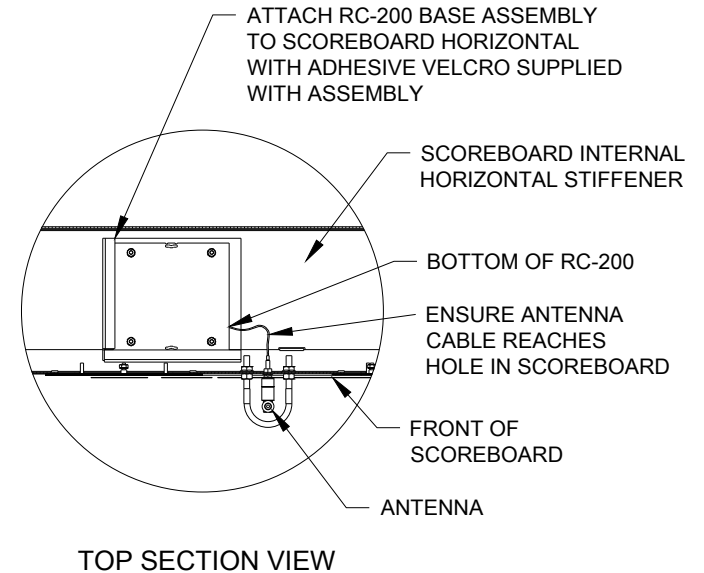

## INSTALLATION INSTRUCTIONS:

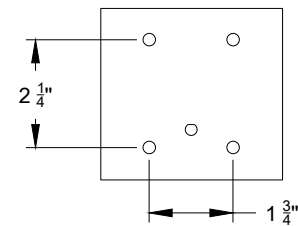
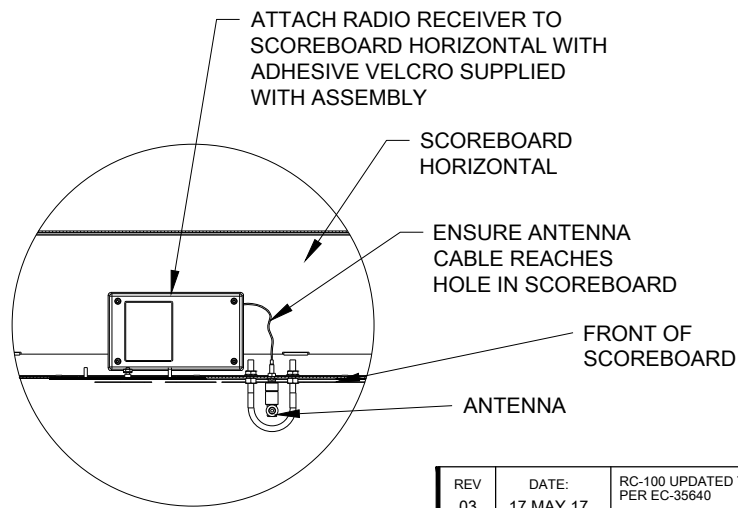

REV 03	DATE: 17 MAY 17	RC-100 UPDATED TO RC-200 PER EC-35640	BY: AHH
REV 02	DATE: 20 NOV 14	REMOVED ASSEMBLIES FROM INSTALLATION INSTRUCTIONS	BY: ASF
REV 01	DATE: 27 MAR 14	PER EC-13907, ADDED INDOOR SCBD ONLY NOTE	BY: KDD

		THE CONCEPTS EXPRESSED AND DETAILS SHOWN ON THIS DRAWING ARE CONFIDENTIAL AND PROPRIETARY. DO NOT REPRODUCE BY ANY MEANS WITHOUT THE EXPRESS WRITTEN CONSENT OF DAKTRONICS, INC. OR ITS WHOLLY OWNED SUBSIDIARIES. COPYRIGHT 2017 DAKTRONICS, INC. (USA)			
PROJECT: INDOOR SCOREBOARDS					
TITLE: RADIO INSTALLATION DETAILS; SCOREBOARDS					
DATE: 21 MAR 13		DIM UNITS: INCHES [MILLIMETERS]		SHEET	REV
SCALE: 1 = 8		DO NOT SCALE DRAWING			03
DESIGN: KSCHNABEL	JOB NO. P1749	FUNC - TYPE - SIZE F - 10 - A		1130990	
DRAWN: KSCHNABEL					

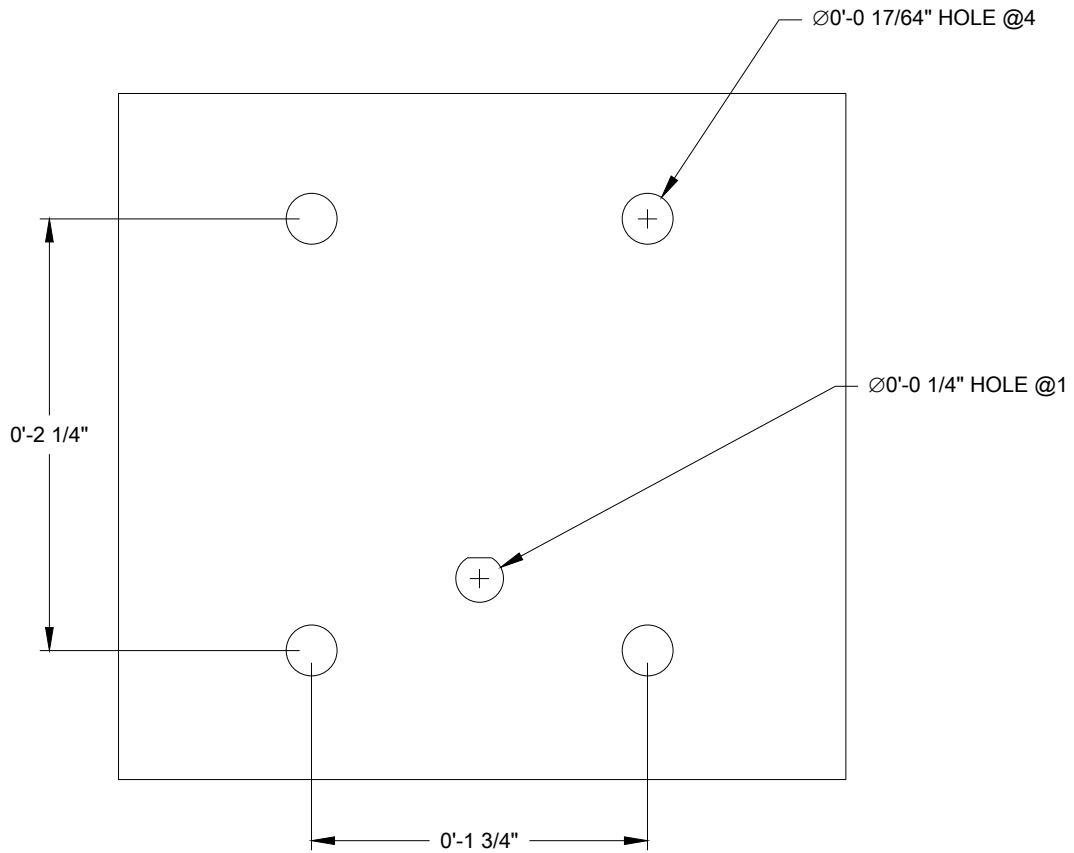

FRONT VIEW  
 ANTENNA AND U-BOLT  
 HOLE PATTERN

 <b>DAKTRONICS, INC.</b> BROOKINGS, SD 57006		THE CONCEPTS EXPRESSED AND DETAILS SHOWN ON THIS DRAWING ARE CONFIDENTIAL AND PROPRIETARY. DO NOT REPRODUCE BY ANY MEANS WITHOUT THE EXPRESS WRITTEN CONSENT OF DAKTRONICS, INC.	
		DO NOT SCALE DRAWING COPYRIGHT 2014 DAKTRONICS, INC.	
PROJ: INDOOR SCOREBOARDS			
TITLE: RADIO INSTALLATION PATTERN; SCOREBOARDS			
DESIGN: KDRAGT		DRAWN: KDRAGT	
SCALE: 1=1		DATE: 11 MAR 14	
SHEET	REV	JOB NO:	FUNC-TYPE-SIZE
	00	P1749	E - 10 - A
			<b>1166771</b>

*This page intentionally left blank.*

## **B Daktronics Warranty and Limitation of Liability**

*This page intentionally left blank.*



# DAKTRONICS WARRANTY & LIMITATION OF LIABILITY

This Warranty and Limitation of Liability (the "Warranty") sets forth the warranty provided by Daktronics with respect to the Equipment. By accepting delivery of the Equipment, Purchaser and End User agree to be bound by and accept these terms and conditions. Unless otherwise defined herein, all terms within the Warranty shall have the same meaning and definition as provided elsewhere in the Agreement.

DAKTRONICS WILL ONLY BE OBLIGATED TO HONOR THE WARRANTY SET FORTH IN THESE TERMS AND CONDITIONS UPON RECEIPT OF FULL PAYMENT FOR THE EQUIPMENT.

## 1. Warranty Coverage

A. Daktronics warrants to the original end user (the "End User") that the Equipment will be free from Defects (as defined below) in materials and workmanship for a period of one (1) year (the "Warranty Period"). The Warranty Period shall commence on the earlier of: (i) four weeks from the date that the Equipment leaves Daktronics' facility; or (ii) Substantial Completion as defined herein. The Warranty Period shall expire on the first anniversary of the commencement date.

"Substantial Completion" means the operational availability of the Equipment to the End User in accordance with the Equipment's specifications, without regard to punch-list items, or other non-substantial items which do not affect the operation of the Equipment.

B. Daktronics' obligation under this Warranty is limited to, at Daktronics' option, replacing or repairing, any Equipment or part thereof that is found by Daktronics not to conform to the Equipment's specifications. Unless otherwise directed by Daktronics, any defective part or component shall be returned to Daktronics for repair or replacement. This Warranty does not include on-site labor charges to remove or install these components. Daktronics may, at its option, provide on-site warranty service. Daktronics shall have a reasonable period of time to make such replacements or repairs and all labor associated therewith shall be performed during regular working hours. Regular working hours are Monday through Friday between 8:00 a.m. and 5:00 p.m. at the location where labor is performed, excluding any holidays observed by Daktronics.

C. Daktronics shall pay ground transportation charges for the return of any defective component of the Equipment. All such items shall be shipped by End User DDP Daktronics designated facility. If returned Equipment is repaired or replaced under the terms of this Warranty, Daktronics will prepay ground transportation charges back to End User and shall ship such items DDP End User's designated facility; otherwise, End User shall pay transportation charges to return the Equipment back to the End User and such Equipment shall be shipped Ex Works Daktronics designated facility. All returns must be pre-approved by Daktronics before shipment. Daktronics shall not be obligated to pay freight for any unapproved return. End User shall pay any upgraded or expedited transportation charges.

D. Any replacement parts or Equipment will be new or serviceably used, comparable in function and performance to the original part or Equipment, and warranted for the remainder of the Warranty Period. Purchasing additional parts or Equipment from the Seller does not extend the Warranty Period.

E. Defects shall be defined as follows. With regard to the Equipment (excepting LEDs), a "Defect" shall refer to a material variance from the design specifications that prohibit the Equipment from operating for its intended use. With respect to LEDs, "Defects" are defined as LED pixels that cease to emit light. Unless otherwise expressly provided, this Warranty does not impose any duty or liability upon Daktronics for partial LED pixel degradation. Notwithstanding the foregoing, in no event does this Warranty include LED pixel degradation caused by UV light. This Warranty does not provide for the replacement or installation of communication methods including but not limited to, wire, fiber optic cable, conduit, trenching, or for the purpose of overcoming local site interference radio equipment substitutions.

EXCEPT AS OTHERWISE EXPRESSLY SET FORTH IN THIS WARRANTY, TO THE MAXIMUM EXTENT PERMITTED BY APPLICABLE LAW, DAKTRONICS DISCLAIMS ANY AND ALL OTHER PROMISES, REPRESENTATIONS AND WARRANTIES APPLICABLE TO THE EQUIPMENT AND REPLACES ALL OTHER WARRANTIES OR CONDITIONS, EXPRESS OR IMPLIED, INCLUDING, BUT NOT LIMITED TO, ANY IMPLIED WARRANTIES OR CONDITIONS OF MERCHANTABILITY, FITNESS FOR A PARTICULAR PURPOSE, OR ACCURACY OR QUALITY OF DATA. OTHER ORAL OR WRITTEN INFORMATION OR ADVICE GIVEN BY DAKTRONICS, ITS AGENTS OR EMPLOYEES, SHALL NOT CREATE A WARRANTY OR IN ANY WAY INCREASE THE SCOPE OF THIS LIMITED WARRANTY.

THIS LIMITED WARRANTY IS NOT TRANSFERABLE.

## 2. Exclusion from Warranty Coverage

This Warranty does not impose any duty or liability upon Daktronics for any:

A. damage occurring at any time, during shipment of Equipment unless otherwise provided for in the Agreement. When returning Equipment to Daktronics for repair or replacement, End User assumes all risk of loss or damage, agrees to use any shipping containers that might be provided by Daktronics, and to ship the Equipment in the manner prescribed by Daktronics;

B. damage caused by: (i) the improper handling, installation, adjustment, use, repair, or service of the Equipment, or (ii) any physical damage which includes, but is not limited to, missing, broken, or cracked components resulting from non-electrical causes; altered, scratched, or fractured electronic traces; missing or gauged solder pads; cuts or clipped wires; crushed, cracked, punctured, or bent circuit boards; or tampering with any electronic connections, provided that such damage is not caused by personnel of Daktronics or its authorized repair agents;

C. damage caused by the failure to provide a continuously suitable environment, including, but not limited to: (i) neglect or misuse; (ii) improper power including, without limitation, a failure or sudden surge of electrical power; (iii) improper air conditioning, humidity control, or other environmental conditions outside of the Equipment's technical specifications such as extreme temperatures, corrosives and metallic pollutants; or (iv) any other cause other than ordinary use;

# DAKTRONICS WARRANTY & LIMITATION OF LIABILITY

D. damage caused by fire, flood, earthquake, water, wind, lightning or other natural disaster, strike, inability to obtain materials or utilities, war, terrorism, civil disturbance, or any other cause beyond Daktronics' reasonable control;

E. failure to adjust, repair or replace any item of Equipment if it would be impractical for Daktronics personnel to do so because of connection of the Equipment by mechanical or electrical means to another device not supplied by Daktronics, or the existence of general environmental conditions at the site that pose a danger to Daktronics personnel;

F. statements made about the product by any salesperson, dealer, distributor or agent, unless such statements are in a written document signed by an officer of Daktronics. Such statements as are not included in a signed writing do not constitute warranties, shall not be relied upon by End User and are not part of the contract of sale;

G. damage arising from the use of Daktronics products in any application other than the commercial and industrial applications for which they are intended, unless, upon request, such use is specifically approved in writing by Daktronics;

H. replenishment of spare parts. In the event the Equipment was purchased with a spare parts package, the parties acknowledge and agree that the spare parts package is designed to exhaust over the life of the Equipment, and as such, the replenishment of the spare parts package is not included in the scope of this Warranty;

I. security or functionality of the End User's network or systems, or anti-virus software updates;

J. performance of preventive maintenance;

K. third-party systems and other ancillary equipment, including without limitation front-end video control systems, audio systems, video processors and players, HVAC equipment, batteries and LCD screens;

L. incorporation of accessories, attachments, software or other devices not furnished by Daktronics; or

M. paint or refinishing the Equipment or furnishing material for this purpose.

### 3. Limitation of Liability

Daktronics shall be under no obligation to furnish continued service under this Warranty if alterations are made to the Equipment without the prior written approval of Daktronics.

It is specifically agreed that the price of the Equipment is based upon the following limitation of liability. In no event shall Daktronics (including its subsidiaries, affiliates, officers, directors, employees, or agents) be liable for any claims asserting or based on (a) loss of use of the facility or equipment; lost business, revenues, or profits; loss of goodwill; failure or increased cost of operations; loss, damage or corruption of data; loss resulting from system or service failure, malfunction, incompatibility, or breaches in system security; or (b) any special, consequential, incidental or exemplary damages arising out of or in any way connected with the Equipment or otherwise, including but not limited to damages for lost profits, cost of substitute or replacement equipment, down time, injury to property or any damages or sums paid to third parties, even if Daktronics has been advised of the possibility of such damages. The foregoing limitation of liability shall apply whether any claim is based upon principles of contract, tort or statutory duty, principles of indemnity or contribution, or otherwise.

In no event shall Daktronics be liable for loss, damage, or injury of any kind or nature arising out of or in connection with this Warranty in excess of the Purchase Price of the Equipment. The End User's remedy in any dispute under this Warranty shall be ultimately limited to the Purchase Price of the Equipment to the extent the Purchase Price has been paid.

### 4. Assignment of Rights

The Warranty contained herein extends only to the End User (which may be the Purchaser) of the Equipment and no attempt to extend the Warranty to any subsequent user-transferee of the Equipment shall be valid or enforceable without the express written consent of Daktronics.

### 5. Governing Law

The rights and obligations of the parties under this Warranty shall not be governed by the provisions of the United Nations Convention on Contracts for the International Sales of Goods of 1980. The parties consent to the application of the laws of the State of South Dakota to govern, interpret, and enforce each of the parties' rights, duties, and obligations arising from, or relating in any manner to, the subject matter of this Warranty, without regard to conflict of law principles.

### 6. Availability of Extended Service Agreement

For End User's protection, in addition to that afforded by the warranties set forth herein, End User may purchase extended warranty services to cover the Equipment. The Extended Service Agreement, available from Daktronics, provides for electronic parts repair and/or on-site labor for an extended period from the date of expiration of this warranty. Alternatively, an Extended Service Agreement may be purchased in conjunction with this Warranty for extended additional services. For further information, contact Daktronics Customer Service at 1-800-DAKTRONICS (1-800-325-8766).